

HOT RUNNER SYSTEM

SERIES

HR



USER'S GUIDE

RING INJENERING

UM-HR-E001

RTD 0807

IMPORTANT!

This document is designed for users of 'Ring Injenering' HR controllers. Read the document carefully before using HR. Keep this document and the relevant ones, so you can use them at any time, if you need.

The wrong utilization of this device can result in serious trouble, damage or injury.

Due to the wide varieties of temperature controllers, you have to be sure, that this device is suitable for your application.

The company 'Ring Injenering' does not bear responsibility for indirect damage, caused by utilization of this device.

The company 'Ring Injenering' reserves its right to change and improve this document and related equipment at any time without notice. The company does not assume any obligations except for these mentioned in the document.

Number of the document: UM-HR-E001

1st edition, 2007

TABLE OF CONTENTS

1	GENERAL DESCRIPTION	5
2	SAFETY PRECAUTIONS.....	7
2.1	GENERAL INFORMATION	7
2.2	MAIN PRECOUTIONS.....	7
2.3	INSTALLATION.....	7
2.4	WIRING	7
2.5	WORK WITH CONTROLLER	7
2.6	MAINTENANCE	8
3	TECHNICAL DATA.....	9
3.1	OPERATING CONDITIONS	9
3.2	CONDITIONS OF STORAGE.....	9
3.3	DIMENSIONS	9
3.4	POWER SUPPLY	9
3.5	ANALOG INPUTS	9
3.6	CONTROL	9
3.7	OUTPUTS	9
3.8	DIGITAL INPUT.....	10
3.9	DIGITAL OUTPUT.....	10
3.10	COMMUNICATION	11
4	GENERAL DESCRIPTION OF THE HR CAPABILITIES.....	12
4.1	GENERAL DESCRIPTION OF DEVICE OPERATION	12
4.2	OPERATING MODES OF HR CONTROLLER	12
4.2.1	<i>STOP mode</i>	12
4.2.2	<i>SOFT START mode</i>	12
4.2.3	<i>WARM UP Mode</i>	13
4.2.4	<i>CONTROL Mode</i>	13
4.2.5	<i>BOOST Mode</i>	13
4.2.6	<i>STANDBY Mode</i>	14
4.2.7	<i>FAILURE Mode</i>	14
4.3	EVENTS FOR FAULTS	14
4.4	OPERATING MODE OF SEPARATE CHANNELS	16
4.4.1	<i>OFF Mode</i>	16
4.4.2	<i>MANual Mode</i>	16
4.4.3	<i>AUTOMATIC Mode</i>	16
4.4.4	<i>SLAVE Mode</i>	16
5	DESCRIPTION OF FRONT PANEL AND MENUS	18
5.1	DESCRIPTION OF INDICATORS AND KEYS	18
5.2	MENU MAP	21
5.3	NAVIGATION BETWEEN MENUS.....	21
5.4	DETAILED DESCRIPTION OF MENUS.	22
5.4.1	<i>CHANGE OF SETPOINTS screen</i>	22
5.4.2	<i>MAIN SCREEN</i>	22
5.4.3	<i>PARAMETERS CHANGE screen</i>	22
5.4.4	<i>CHANNEL STATUS screen</i>	24
5.4.5	<i>TEMPERATURES IN THE CONTROLLER screen</i>	25

5.4.6	ZONES SETTING screens	25
5.4.7	FAILURE SETTINGS screens	27
5.4.8	MODE CHANGE screen.....	28
5.4.9	GENERAL SETTINGS screens.....	29
5.4.10	SAVE / READ SETTINGS screens.....	32
5.4.11	CONFORMITY TEST screens.....	33
5.4.12	Screen CLOCK.	34
5.4.13	EVENTS screen.....	34
5.4.14	OUPUT MODULES screens.....	35
5.5	DESCRIPTION OF MESSAGES ON STATUS SCREEN.....	35
6	MAIN OPERATIONS WITH HR	39
6.1	SETPOINT CHANGE OF ONE ZONE	39
6.2	CHANGE MODE OF ONE ZONE.....	39
6.3	SETPOINT CHANGE OF SEVERAL CONSEQUENT ZONES	39
6.4	START	40
6.5	STOP	40
6.6	BOOST.....	40
6.7	STANDBY	40
6.8	MONITORING OF PARAMETERS ON THE LED INDICATION.....	40
6.9	SETTING OF PID PARAMETERS.....	41
6.10	STORING AND READING OF ALL SETTINGS.	41
6.11	SETTING OF FAILURE PARAMETERS	42
7	STARTING OF THE CONTROLLER FOR THE FIRST TIME	43
7.1	INSTALLATION.....	43
7.2	CONNECTION OF CABLES AND SWITCHING ON POWER SUPPLY.	43
7.3	INITIAL SETTING OF ZONES	43
7.4	SETTING OF MAIN PARAMETERS.....	43
7.5	START AND STOP OF HEATING.....	44
8	FAILURES.....	45
8.1	FAILURE EVENTS AND CAUSES.....	45
8.2	POSSIBLE FAULTS AND THEIR ELIMINATION.....	47
8.2.1	Burnt zone fuse.....	47
8.2.2	Burnt fuse of controller.	47
9	ADDITIONAL CAPABILITIES OF HR.	48
9.1	DIGITAL INPUTS AND OUTPUTS WITH GENERAL PURPOSE.	48
9.2	CONNECTING IN JOINT CONTROL WITH PRESSURE GUN.....	49
9.3	COMMUNICATION	49
9.4	PARALLEL OPERATION OF SEVERAL HR CONTROLLERS.	49
	APPLICATION 1. DESCRIPTION OF EVENTS.....	50
	APPLICATION 2. SIGNAL LAYOUT OF EXTERNAL CONNECTORS.....	51

1 GENERAL DESCRIPTION

HR is a multi-channel microprocessor temperature controller designed to control heating of nozzles and channels of hot runner system matrixes. It is specially developed for obtaining maximum flexibility and reliability of the system, as well as for simplicity and convenience when used by the user. HR is also open to be connected to another control. As a whole, the device is light, convenient and compact.

Flexibility

- 3 available models - HR8, HR16 and HR24 respectively with 8, 16 and 24 zones;
- possibility of paralel work of several HR units in order to control greater number of zones;
- zone control according to the PID Control Law for regulation with adjustable parameters;
- possibility for putting of output modules of different power in each model;
- option of automatic or manual control of output of each zone;
- possibility for manual slave the output of one zone to another zone;
- individual zone settings to failure limits;
- Take out the signals to HD connectors with or without cables as per user's desire

Reliability

- possibility for soft start of heating to dry out the moisture that has collected in the cold heating elements;
- possibility for simultaneous BOOST of temperatures of all zones after warm up starts;
- possibility for auto slaving of output of one zone to another on temperature sensor failure;
- constant diagnostics for problems, and alarms for: wrong parameters (in the memory), temperature sensor failure, non heating or overheating of a zone, exceeding of maximum temperature, temperature out of the set alarm and failure limits, overheating of output modules of the device, etc.;
- storing of parameters in nonvolatile FLASH memory;
- protection against change of key parameters by a password on level 'adjust';
- turning on and off of power elements when passing through zero of supply voltage for low EMI level;
- protection against overheating of output modules;
- protection against output failure (short circuit in heaters) by fast fuses for each zone;
- Protection against overheating of zones (at short circuit in control element), disconnecting power supply by built-in contactor;

Easy-to-use

- digital and navigation keyboard, and 4 x 20 characters LCD for setting parameters;
- bright 3-digit 7-segment indication of each zone for remote monitoring of the following parameters: setpoint, current temperature, percent of output power, difference between set and current temperature, etc.;
- LEDs for each channel, indicating switched on heater or error;
- common LED indicating that temperature of all zones is within set limits;
- simple menus on operator's level;

- independent keys for simultaneous start, stop, temperature BOOST or STANDBY in all zones;
- possibility for individual or group setting of parameters;
- possibility for storing of 10 settings of all parameters for quick presetting when changing the matrixes;
- built-in settings of PID parameters for two types of zones – ‘mainfold’ and ‘nozzle’.
- easy access to fuses of heaters from front panel;

Extensibility

- availability of external digital input, adjustable as ‘start/stop’, ‘decrease’ or ‘increase’ for HR control from outputs of other devices;
- availability of external relay output, adjustable as: ‘switched on’, ‘switched off’, ‘alarm’ or ‘temperatures OK’ for signalization to other devices;
- possibility for connection to network or computer through communication RS485 (own protocol or MODBUS) or RS232 for realization of general control or monitoring and archiving of temperatures.

In the table below are given the HR controller models.

Model	Number of regulated zones
HR8	8 zones maximum
HR16	16 zones maximum
HR24	24 zones maximum

In the next table are given versions of output modules.

Number of zones per module	Current capacity
1	15 (30) A
2	12 (24) A
4	8 (15) A
6	6 (12) A
8	4 (8) A

The values in brackets are for added outside fan for additional forced cooling.

2 SAFETY PRECAUTIONS.

2.1 General information

Providing safety operating equipment for people and machines is the most important task and responsibility of designers and executors in implementation of automation systems. Controller failure may injure people or destroy equipment.

2.2 Main precautions

HR Controller is designed for utilization in industrial environment, but not in systems, which may harm human health.

During installation, connection, maintenance and operation with HR Controller, is supposed that the user has basic knowledges for industrial systems for automation and their application. If HR Controller is incorrectly utilized, it is possible to occur current rush, failure or fire.

Please contact 'Ring Injenering', if you have any questions on this document.

2.3 Installation

Install HR CONTROLLER and connected equipment, according to recommendations in this document. If Controller operates at temperature, humidity, dust or gas environment, exceeding its limits, electric shock, failure or fire is possible to occur.

Install HR CONTROLLER away from sources of static electricity (pipes for taking up material or electrified pieces). Otherwise failure or wrong operation of HR is possible to occur.

Disconnect power before installation or disassembly of any block, module, panel or connector. Otherwise there is chance of electric shock or failure of HR CONTROLLER and equipment connected to it.

Wires, screws or other metal pieces, going into the controller, may cause failure or fire. Take respective safety precautions during installation and wiring.

Immediately disconnect from power source, if smoke or burning smell is coming out from controller. In such cases controller operation may cause fire or electric shock. The same may occur when an unauthorized person is attempting to repair it.

Controller earth terminals must always be securely connected with the ground.

Computer connected to controller must be connected with the ground.

Do not attempt to repair HR controller yourself. Contact 'Ring Injenering' for repair.

2.4 Wiring

Disconnect from mains before wiring, in order to avoid risk of electric shock.

Controller operation without earthing may cause electric shock or failure. Connect controller earth terminal to network earthing.

Higher voltage to HR controller may cause fire. Power the HR controller only within range mentioned in this document.

Wrong wiring may cause fire, failure or electric shock. Observe national regulations for setting up of electric installations and earthing.

2.5 Work with Controller

If you want to manually set up an output, carefully check if this is safe.

Disconnect from mains when replacing fuses.

Replace fuse only with a new one of the same type and value.

Use controller only for its purpose.

Do not try to change controller hardware or software. This may cause electric shock, failure or fire.

Check if wires and connectors are correctly and securely connected to HR controller. Poor contact may cause wrong operation, failure or fire of controller and equipment connected to it.

2.6 Maintenance

Disconnect from mains before unplugging or replacing of blocks, modules, connectors or wires. Otherwise there is chance of electric shock or failure of HR controller and equipment connected to it.

Replace burnt fuses only with similar ones in terms of value and type. Breaking this rule may cause failure or fire in controller.

Do not disassemble HR controller. Otherwise electric shock or failure in controller is possible.

In case of replacement of modules, be extremely careful in order to avoid wrong wiring.

Carry out necessary daily and periodical controls and cleaning, in order to maintain the system in normal working conditions and avoid undesired problems.

Contact 'Ring Injenering' for repair in case of failure of controller. 'Ring Injenering' does not guarantee correct operation and safety when unauthorised people are carrying out repair.

3 TECHNICAL DATA

3.1 *Operating conditions*

Operating Temperature	0 - 45 °C
Relative Humidity	0-70 % RH without condensation
Environment	Without gases, causing corrosion
Dust level	<10mg/m ³ .
Protection	IP40

3.2 *Conditions of storage*

Storage Temperature	-25 - 70 °C
Relative Humidity	5 - 95 % without condensation

3.3 *Dimensions*

Dimensions (w, h, d)	492mm x 168mm x 392mm
----------------------	-----------------------

3.4 *Power supply*

Power Supply	3x230 VAC +10% -20% + N + E
Consumption Without Load	30 VA max.

3.5 *Analog Inputs*

Operating range:	
- TC Type J	from -99 °C to 750 °C
- TC Type K	from -99 °C to 500 °C
Basic error	±0,2% ±1LSB (range 0-Tmax)
Error from ambient temperature compensation	± 1 °C max
Cold junction compensation	internal
Resistance of temperature sensors	50 Ω max
Time for input measurement	1 sec
Digital filter at input	13 Hz
Measurement resolution	12 bits
Insulation between inputs of thermocouples and power supply and digital part	1000 VDC

3.6 *Control*

Control Law	PID
Output Control	PWM
PWM Resolution	10ms

3.7 *Outputs*

Output Switching Element	Triac with zero cross detection
Load Voltage	220 VAC rated
Output Current for different types of output modules	4 A, 6 A, 8 A, 12 A, 15 A max.
Insulation between outputs and Digital Part	1500 VDC max

3.8 Digital input

Operating Voltage (from internal source)	15 - 30 VDC
Rated Input Current	5 mA
Input Resistance	4,7 kOhm
Isolation Voltage	2000 V DC
Propagation Time at:	
• Transition from '0' to '1'	10µS
• Transition from '1' to '0'	10µS
Connector Wires	1,5 mm ² max

Connection diagram:

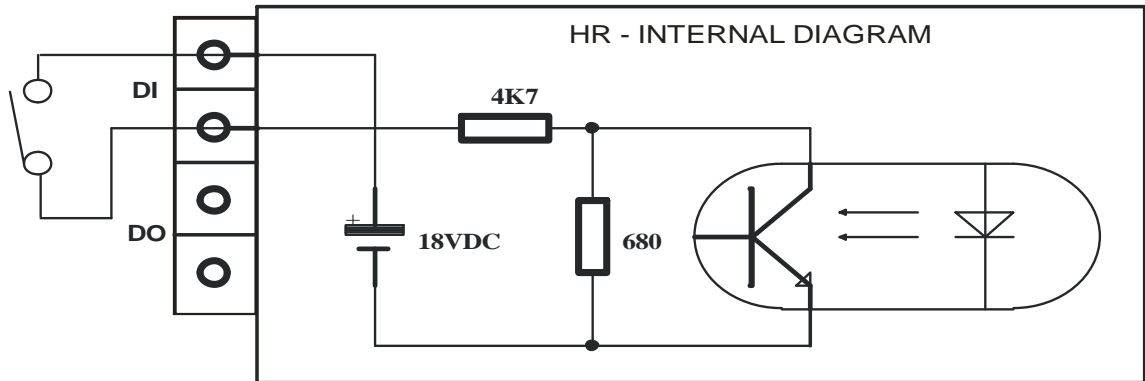

3.9 Digital output

Type	Relay output with normally-open contact
Operating Voltage	Up to 250 V AC or up to 30 V DC
Maximum Output Current	2A
Maximum Frequency at Resistance Load	10 Hz
Minimum Number of Operating Cycles	300 000
Lag Time at:	
• Turning on	15 ms max
• Turning off	15 ms max
Isolation Voltage	2000 VDC
Connector Wires	1,5mm ² max

Layout of terminals and connection diagram:

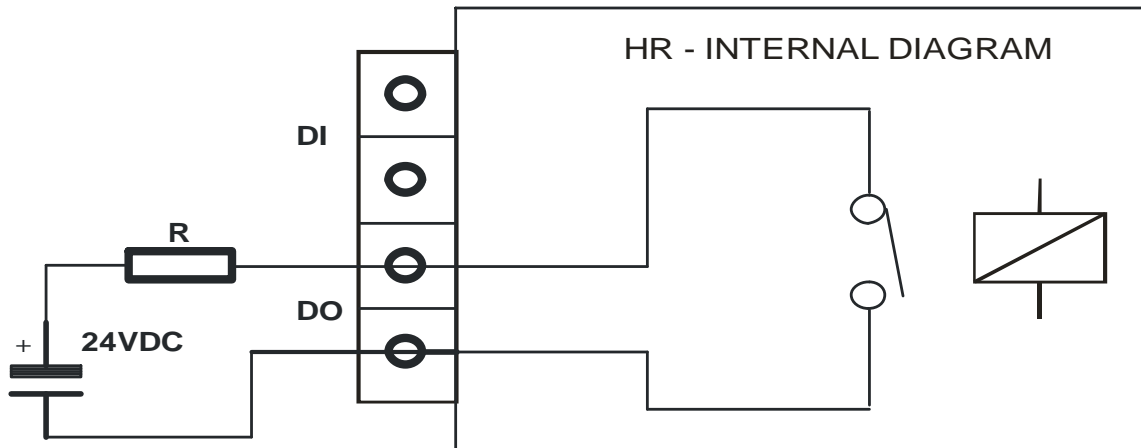

3.10 Communication

- **RS485**

Physical
 Topology
 Speed
 Maximum Length
 Number of Nodes
 Method of Access to the Line
 Maximum Message Length
 Token Rotation Time:

RS485, twisted pair
 Bus
 9600 / 38400 bit/s
 200 m
 31 / 3
 Token like
 32 bites
 1,5s at 31 nodes and 9,6kB/s
 35ms at 3 nodes and 38,4kB/s

Connector for RS485:

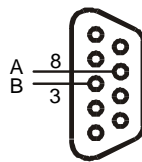

- **RS232**

Physical
 Speed
 Maximum Length
 Number of Nodes
 Message Format:

- Start bit
- Data
- Parity Control
- Stop Bit

RS232C
 9600 / 38400 bit/s
 15m
 2
 1
 8 bits
 1 bit
 1

4 GENERAL DESCRIPTION OF THE HR CAPABILITIES

4.1 General description of device operation

HR is a multi-channel microprocessor temperature controller, designed to control heating of nozzles and channels of hot runner system matrixes with up to 24 zones. At the same time, it is much more than a number of 24 controllers. This device has a great number of modes, ensuring safety and reliable operation of matrixes.

After turning on power, device checks whether the following conditions are occurred:

- the check-sum parameters in the memory is valid;
- availability of sensors in all zones, which are configured for AUTOMATIC mode;
- temperatures of all zones are under maximum temperature;
- temperatures of power modules and inside the box are within their limits.

If any of these conditions is not fulfilled, on LCD appears a message about the problem found. The device can not start in run mode, until all problems are not eliminating.

When conditions are fulfilled, device can be started. This is done by pressing and holding START key. After having started, the device passes through the following modes:

- soft start (if allowed);
- warm up (if allowed);
- control.

Every moment, after ending SOFT START mode, the device can be switched in BOOST or STANDBY mode. In all control modes HR continuously monitors availability of failure situations, and if any, goes into FAILURE mode, by turning off heating of all zones. Main screen upper row (active screen after powering up) always displays current operating mode.

4.2 Operating modes of HR controller

4.2.1 STOP mode

This is a mode, in which all outputs are maintained off and there are no failure messages. RUN and ERROR LEDs do not light. Controller goes into this mode after powering up.

In this mode the controller monitors if the following conditions are fulfilled:

- availability of zone, configured in mode, different from OFF;
- there are sensors in all zones, configured in automatic mode;
- temperatures of all zones are under the maximum allowed temperature;
- temperatures of power modules and inside box are within permissible limits;

If all conditions are fulfilled, main screen displays STOP MODE / HOLD START key, as well as the number of zones, which are: in AUTOMATIC mode, SLAVE, and in MANUAL mode (modes of particular zones are described more in detail in part 4.3).

4.2.2 SOFT START mode

This operating mode is used for drying heaters from moisture in case of heating stopped for a long time. This is necessary as availability of moisture in heaters may cause burning of outputs, fuses, heaters or failure of temperature sensors.

This operating mode runs on several steps, gradually increasing power, supplied to heaters. For a given step, output power rate of all zones is equal, whatever their main mode and type. Heating is not provided only to zones in STOP mode.

This mode is automatically skipped by the controller if temperatures of all zones configured in AUTOMATIC mode are above 50°C.

Entering into this mode is determined by SOFT START parameter in MODES menu. If value is YES, mode is active when starting heating. Respectively if NO, this mode is not activated.

During this operating mode, BOOST and STANDBY modes are not active.

4.2.3 WARM UP Mode

This mode is used for simultaneous heating of entire matrix. The purpose is to avoid areas with big temperature differences, which could cause internal stress in materials and possible bending of matrix. Moreover, time to reach matrix temperature operating readiness depends on heating speed of slower zones.

In this mode controller monitors which zone heats up most slowly and controls remaining zones, so that their temperatures do not exceed its increment— their temperatures setpoints become equal to the slowest zone temperature. This is reflected in SETPOINT parameter value, respectively SP on LED indicator.

WARM UP mode is finished when a zone reaches temperature 50°C from its setpoint.

Passing through this mode is determined by WARM UP parameter in MODES menu. If value is YES, mode is allowed after starting of warm up. Respectively, if NO, this mode is not activated.

In this mode controller responds to instructions BOOST and STANDBY.

4.2.4 CONTROL Mode

This is a main operating mode of HR controller, in which set temperatures of all zones are automatically maintained.

Entering into CONTROL mode is carried out by pressing and holding up of START key. When controller is in CONTROL mode, RUN LED lights on the front panel.

In this mode controller monitors conditions which could cause failure (if allowed):

- are there sensors on every zone, configured in AUTOMATIC mode;
- is there a zone above maximum temperature;
- are power module temperatures and inside box in permissible limits;
- are zone temperatures within limits of common failure limit;
- are zone temperatures within 'temp limits OK';
- is there a zone with discontinued heating;
- is there a zone with continuous (uncontrollable) heating.

4.2.5 BOOST Mode

This mode is used to BOOST setpoints of all zones with particular temperature. This is necessary when in the initial operation of machine there is standstill material in nozzles and for its melting higher temperature for some time is required.

Setpoints of zones in this mode are determined as sum of setpoint of zone in automatic mode and setpoint for BOOST from SETPOINTS OF ZONES menu.

Controller can enter into BOOST mode by pressing and holding up BOOST key or from digital input of rear panel (if configured). Controller remains limited time in this

mode (determined by 'MAX Increase' parameter in MODES menu), after that it returns to CONTROL mode. Returning to CONTROL mode can be done before this by pressing BOOST key.

In this mode controller monitors same alarms, as in CONTROL mode.

4.2.6 STANDBY Mode

This mode is used to reduce setpoints of all zones with a particular temperature. This is used when machine cycle must be stopped for some time. In this case zone temperatures are reduced but at the same time there is possibility for quick return to operating temperatures.

Setpoints of zones in this mode are determined as difference between zone setpoint and STANDBY setpoint from ZONE SETTING menu.

In this mode controller monitors the same alarms as in CONTROL mode.

Controller can enter into STANDBY mode by pressing and holding up STAND BY key or from digital input of rear panel (if configured). Controller can remain unlimited time in this mode. Return to CONTROL mode is done by pressing again STAND BY key.

4.2.7 FAILURE Mode

Controller goes into this mode in case of failure situation.

In ERROR mode all outputs are switched off, as well as contactor powering the zones. On front panel glows ERROR LED, the main LCD reads FAILURE, followed by explanation about its type. If failure is caused by definite zone(s), the ALR LED of respective zone glows too.

In this mode controller does not monitor occurring of new errors.

To escape from FAILURE mode, press ENTER or ESC key, then controller goes into STOP mode.

4.3 Events for faults

Depending on controller and zone operating mode, HR monitors accruing of faults. These are:

- wrong configuration – it may occurs after turning on of power supply and shows that some parameters have been erased (wrong check-sum);
- missing sensor – shows that for some zones in AUTOMATIC mode a sensor is missing or it has failed;
- temperature above maximum - temperature of fixed zone(s), exceeding setpoint of maximum temperature in FAILURE SETTINGS menu;
- temperature of output module above maximum admissible – occurs if any power module temperature exceeds above the admissible temperature of 100°C;
- controller internal temperature above admissible – occurs when internal sensor measures box internal temperature above 70°C;
- non heating of zone – shows that heating of zone is constantly switched on, and its temperature does not increase (e.g. burnt heater, fuse, output or broken connection). In ZONE HEATING menu, is set time interval ('Failure Time' parameter), during which temperature should increase at least by several degrees ('Min. Increase' parameter). For beginning of the interval is considered the moment when output reach 100%. In this menu is also specified whether occurring of this event causes entering into FAILURE mode or no (through FAILURE parameter);

- overheating of zone – shows that heating of zone is switched off, and temperature is constantly increasing (output short-circuited). In ZONE OVERHEATING menu is set time interval ('Failure Time' parameter), for which temperature should not increase more than set degrees ('Max. Increase' parameter). For beginning of the interval is considered the moment when output reach 0%. In this menu is also specified whether receiving of this message may cause entering into FAILURE mode or no (through FAILURE parameter);
- violated limits zone OK – shows that zone temperature is beyond range of Setpoint±limits, set in parameter 'Zone Limits OK' in ZONE SETTING menu. This alarm may cause entering into FAILURE mode, depending on 'Failure from Violated Limits OK' parameter from FAILURE SETTINGS menu;
- violated global limits – failure indicating that zone temperature is out of range of Setpoint ±value set in 'Common failure limit' parameter. Going out of these limits unconditionally brings the controller into FAILURE mode.

Detailed description of failure events and their possibilities are given in item 8.1.

4.4 Operating Mode of Separate Channels

Together with controller operating modes, described in the above item, each channel allows individual setting of its operating mode.

Configuration of zones can be done from three different menus: PARAMETER CHANGE, CHANNEL STATUS CHANGE or ZONE SETTING menu.

Modes of zones are: OFF, MANual, AUTOMatic and SLAVE.

4.4.1 OFF Mode

In this mode, zone output is kept switched off and occurring of failure situations is not monitored for a given zone. Mode is selected by assigning text OFF for zone mode.

4.4.2 MANual Mode

In this operating mode zone output is switched on for a set part (in %) from scanning time. Realization of manual mode is carried out with PWM (pulse-width modulation). For example, if scanning time is 3 seconds, and set percentage at output is 60%, the output (respectively heater) is on for 1,8 seconds and off for 1,2 seconds.

It should be underlined that by its nature manual mode does not provide maintaining of temperature. It can not respond to interferences (e.g. change of supply voltage, load change, etc.).

Manual mode is selected, by assigning text MAN for zone mode, while output percentage is set by OUTPUT SETTING parameter.

4.4.3 AUTOMatic Mode

This is the main operating mode of zone. In this mode is measured zone temperature, then it is compared to the setpoint and change value of output percentage, so that to maintain set temperature. Zone control is carried out by PID (Proportional-Integral-Derivative) controller. User could make PID controller settings, but HR has saved fixed settings, providing optimal regulations in most cases. These settings are selected as for zone type is set NOZZLE or MAINFOLD. See item 6.9 for more details about PID regulation.

Automatic mode is selected by assigning text AUTO in mode setting parameter.

4.4.4 SLAVE Mode

In this mode, heating control (% at output) of one zone is identical to heating control of another zone. This is mostly required in cases when there is a faulty or missing thermocouple of some zone. Then zone is 'slaved' to another zone with similar physical and electrical characteristics, e.g. to a zone with similar layout of matrix and the same power of heater. The number of zone to be slaved to, is set in AUTO SLAVE parameter or SL TO ZONE, depending on the situation, which requires slaving.

If zone operates in automatic mode (and its automatic slaving is set) and if during operation its thermocouple fails, HR will not alarm for failed sensor (and will not enter into FAILURE mode), but will automatically slave zone output to another zone, thus continuing controller operation in CONTROL mode.

It should be mentioned that entering from automatic into slave mode during operation does not put the zone continuously in slave mode. After repairing sensor, it goes again into automatic control mode (entering before that into STOP mode).

User should decide whether zone can be slaved to another zone. If this is possible, in 'Auto slave' parameter should be written zone number, to which to be slave. But if there is not a zone with similar characteristics, should be written 0 in 'Auto slave' parameter, and if sensor fails, it will enter into FAILURE mode.

A zone can also be slaved manually to another zone, regardless whether there is sensor or not, if selected SL in the mode parameter.

5 DESCRIPTION OF FRONT PANEL AND MENUS

Main operator's activities with controller are carried out from HR front panel. This chapter describes in detail HR elements of operator's interface, as well as menus and parameters, which influence controller operation, and what can be monitored on LCD, and on LED indicators.

5.1 Description of indicators and keys

On the figure below are given main elements of operator's interface, connected with indication and change of controller operating modes.

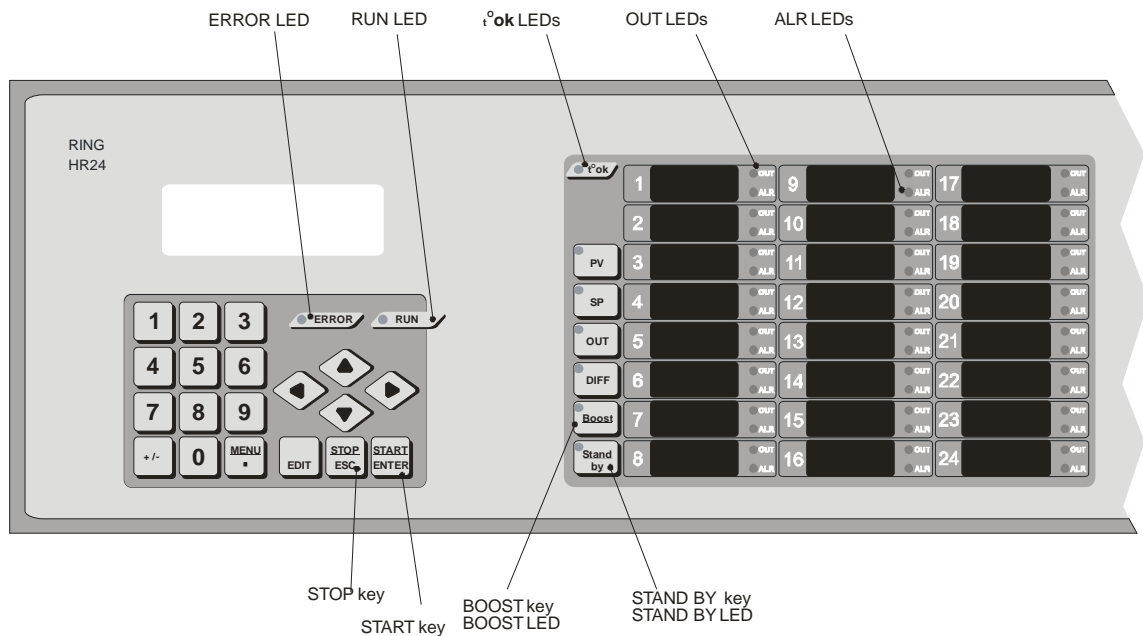

ERROR LED (red) – lit when controller is in FAILURE mode.

RUN LED (green) – lit when controller is started, i.e. outputs are turned on for heating control.

t° OK LED (green) – lit when all zones, which are in automatic mode, are within 'Limits zone OK' of setpoint.

OUT LEDs (green) – flash when switched on output of respective zone.

ALR LEDs (red) – flash if respective zone have caused an failure event.

STOP key – holding up of this key pressed in any mode and menu, brings controller into STOP mode.

START key – holding up of this key pressed in any mode and menu, starts control (if start conditions are fulfilled). Controller goes in one of following modes: SOFT START, WARM UP or CONTROL, depending on settings and current values of zone temperatures.

BOOST key – when holding up this key pressed in started control controller goes into BOOST mode. Key does not operate in modes STOP, SOFT START and FAILURE.

BOOST LED (green) – lit if controller is in BOOST mode.

STAND BY key – when holding up this key pressed in started control, controller goes into STANDBY mode. Key does not operate in mode STOP, SOFT START and FAILURE.

STAND BY LED (green) – lit if controller is in STANDBY mode.

On the following figure are given main elements of operator's interface, related with setting and monitoring of HR parameters.

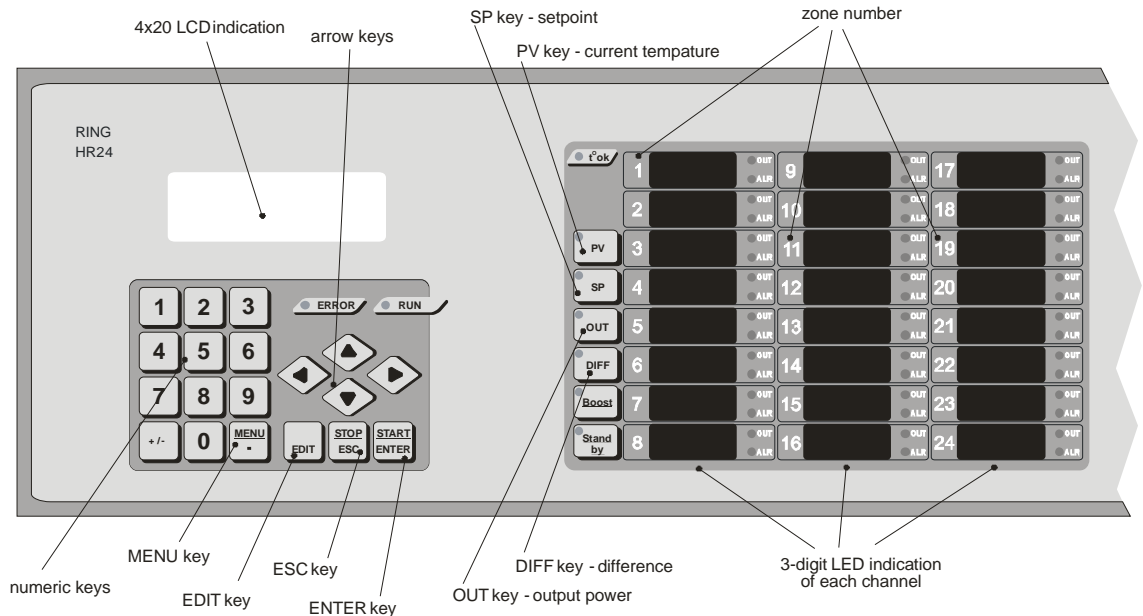

4x20 LCD - 4 x 20 characters LCD with backlight. Information entered on screen is called 'menu'. In most cases top line indicates menu name.

Arrow keys – they are used for navigation in the menu system. Moreover, in parameter edit mode, up and down arrow keys select value (for text parameters), and left and right arrow keys for shifting from one parameter to another.

MENU key – when holding up this key pressed, on LCD screen appears the main menu, also called main screen.

EDIT key – current LCD menu enters into parameter edit mode - value of first parameter begins to flash. A second pressing of this key quits edit mode. **When in edit mode it is not possible to go to another menu.**

ESC key – in edit mode (some value is flashing) cancels made change of value and keeps old value.

ENTER key – in edit mode (some value is flashing) saves new value and shifts to edit next parameter.

PV key – take out to LED indication the current temperature of all zones. Information on LED has two modes. The first mode, which is active after turning on power, shows information from temperature sensors of all zones (glows *n*c, if there is no connected sensor or sensor has failed). The second mode shows only temperature of zones in automatic mode. Moreover, in this mode zones, which temperature has not gone in 'Limits zone OK', flash. **Shifting between the two modes is done by holding down PV key.**

SP key – take out to LED indication the setpoints of all channels. Depending of the zone mode different information is displayed:

Zone mode	Indication	Explanation
Switched off		All three zone indications are switched off.
Manual mode	U35	U is displayed, followed by setpoint at output in percent (35% in the example). Setpoint of 100% is indicated 99%.
Automatic mode	280	Zone setpoint in degrees (280 in the example).
Slave	P 5	P is displayed, followed by the number of zone, to which current zone is slaved (5-th in the example).

OUT key – take out to LED indication the current percent of outputs for each zone. Control mode does not display information about zones, which are switched off or slave.

DIFF key – take out to LED indication the difference between measured temperature and setpoint. This information is only displayed for zones in automatic mode.

Next to each *PV*, *SP*, *OUT* and *DIFF* key there is a LED, indicating which value is indicated at the moment. If HR is in PARAMETERS CHANGE mode, no LED next to these keys is lit, while on LED indicators are shown values of edited parameter for each zone (for further details see PARAMETERS CHANGE menu).

5.2 Menu map

The following figure shows the menu map.

HR MENUS

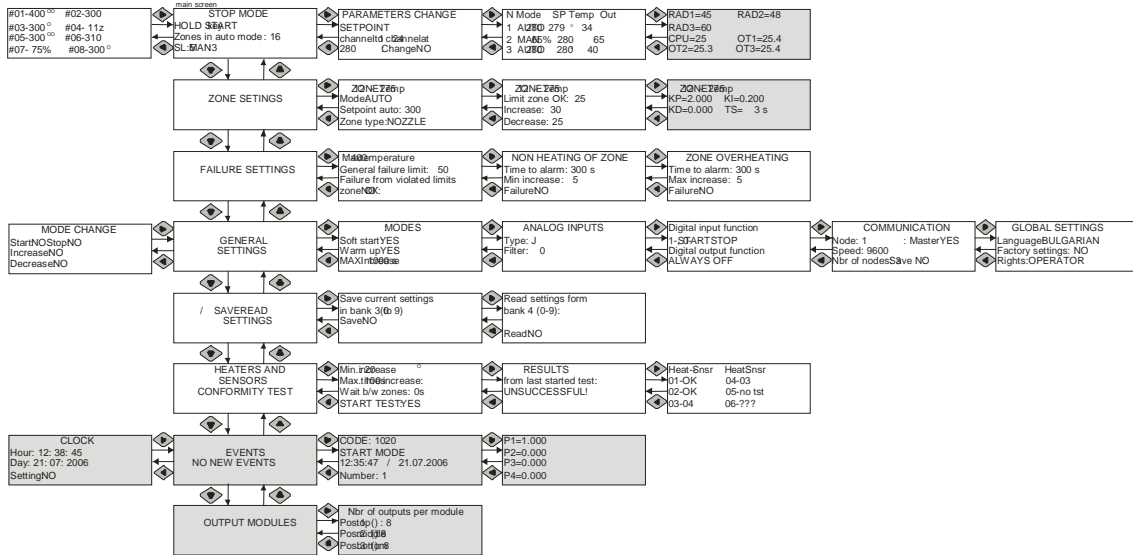

Shaded menus are only accessible in ADJUST level

5.3 Navigation between menus

Screen which appears first after turning on of power is designated as **main** screen (see the map). In the following description, layout of other menus will be given according to this screen. Main screen (from any other screen) can be reached, in the quickest way, by holding down MENU key.

Navigation between separate menus is realized by pressing arrows (if menu is not in edit mode). For example, if from main screen ANALOGUE INPUTS screen should be reached, down arrow should be pressed three times and then right arrow two times.

Menus have two levels of access – OPERATOR and ADJUST. On ADJUST level, user has access to additional parameters, menus, additional diagnostic information, information about turning on and turning off of controller, etc. After turning on the menus have OPERATOR level of access. Shifting to ADJUST level is done from GLOBAL SETTINGS menu through 'Rights' parameter. Change of access mode is protected by a password.

In order to change a parameter it is necessary to carry out the following sequence of actions:

1. In respective menu press EDIT. The first parameter begins to flash on screen.
2. Using right arrow key go to the desired parameter.
3. If the parameter is digital, its new value is set using numeric keys. If it is a text parameter, select the new value by up or down arrows.
4. Press ENTER to save the new value or ESC to keep the old value.
5. To change another parameter, repeat actions from item 2 to item 4.
6. To end editing, press EDIT (edit finishes also if you press ENTER of the last parameter).

5.4 Detailed description of menus.

Follows detailed description of separate menus. Descriptions go from left to right and from top to bottom according to the menu map. For each menu is described its position toward main screen. Open main screen from each menu by holding down the MENU key.

5.4.1 CHANGE OF SETPOINTS screen

Position: Opens by left arrow from the main screen.

#01-400°	#02-300°
#03-300°	#04- 11z
#05-300°	#06-310°
#07- 75%	#08-300°

Access rights: OPERATOR

Description:

In this screen are setpoints for zones are changed. Change is done by using up and down arrows until reaching a screen displaying the desired zone, press EDIT, enter a new value (e.g. 320) and press ENTER.

After the setpoint a symbol is displayed, meaning the mode of zone operation. You will find an example in the table below:

Designation	Explanation
300°	Zone is in automatic mode with 300 degrees set.
11z	Zone is slave to zone 11.
75%	Zone is in manual mode with setpoint for output 75%.

5.4.2 MAIN SCREEN

Position: Open from every screen by holding up MENU key.

main screen

STOP MODE HOLD START key Zones in auto mode: 16 SL: 5 MAN: 3

Access rights: OPERATOR

Description:

On the main screen there are no parameters to enter. Information displayed on it, depends on controller operation mode and results from failure situations check. Detailed description of possible messages on the main screen is given further in this part in the item 'Description of status screen messages'.

5.4.3 PARAMETERS CHANGE screen.

Position: Open by right arrow from the main screen.

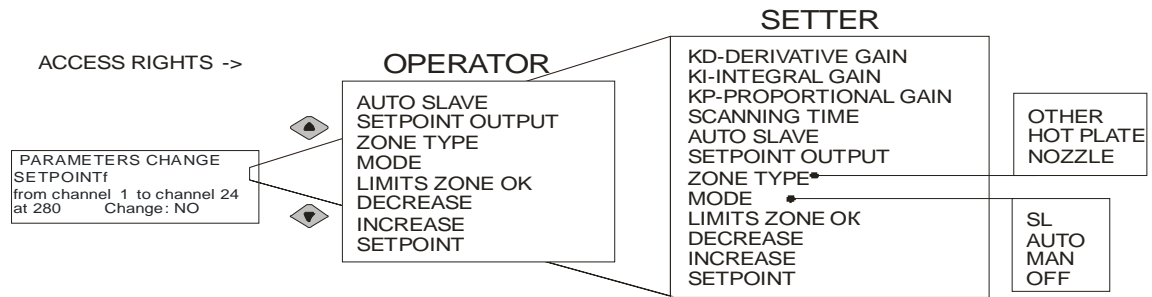

Access rights: full access in **ADJUST** / partial access in **OPERATOR**

Description:

This screen is designed for simultaneous parameters change of several consequent zones. Screen has 5 parameters: parameter, which is changing, from which channel number to which channel number is valid the change, new value of parameter, and finally change command. Values which could be changed (parameter 1) and their permissible values (parameter 4) are given in the table below.

Parameter 1	Parameter 4	Explanation
AUTO SLAVE	0, 1..N N-number of zones	The parameter has two meanings, depending on zone mode: - In AUTO mode indicates to which zone to slave automatically the current zone in case of failure of temperature sensor, in order to continue operation in control mode. Value 0 causes entering into FAILURE mode in case of sensor failure. - In SL mode indicates zone to which current zone is slaved manually. The zone is considered in OFF mode when value is 0.
OUTPUT ON MANUAL	0..100 [%]	Setpoint for zone output, when in manual mode. Value is in percent.
ZONE TYPE	NOZZLE MAINFOLD OTHER	Setting of NOZZLE zone type or MAINFOLD (depending on its location) sets parameters of PID controller in suitable values for optimal control.
MODE	SL AUTO MAN OFF	Zone mode. Modes are described in detail in item 4.4.
LIMITS ZONE OK	0..99 [°C]	Temperature difference compared to setpoint, within which the zone is with operating temperature and failure event is not induced.
STANDBY	0..400 [°C]	Value by which is decreased setpoint in STANDBYmode.
BOOST	0..99 [°C]	Value by which is increased setpoint in BOOSTmode.

Parameter 1	Parameter 4	Explanation
SETPOINT	0..999 [°C]	Setpoint for zone temperature, to be maintained in AUTO mode.
Scan time*	1..255 [s]	Period of output PWM.
KP-PROP GAIN*	0.000..99.999	Proportional gain of PID controller.
KI-INTEG GAIN*	0.000..99.999	Integral gain of PID controller.
KD-DER GAIN*	0.000..99.999	Derivative gain of PID controller.

* These parameters are accessible only with **ADJUST** rights for access.

Setting of parameters by this menu is done as follows:

1. By pressing EDIT, the first parameter, whose value will be changed, begins to flash. At the same time on LED indication appears the current value of this parameter for all zones. Through up and down arrow keys select the parameter, whose value will be changed and then ENTER is pressed.

2. The second parameter - the first zone, whose value will be changed, begins to flash. Follows setting of desired number from numeric keypad and pressing of ENTER.

3. The third parameter begins to flash. Numeric keypad sets to which zone inclusive) to make change of value and then press ENTER. On LED indication at the same time flash zones in selected range. Numbers, entered as second and third parameter should be from 1 to the number of zones in controller, the second parameter should be smaller or equal to the third.

4. The fourth parameter value begins to flash. If the value is digital, it is set by the numeric keypad, if it is a text – selected by up and down arrow keys. Press ENTER.

5. The fifth parameter begins to flash- “Change”. Select YES by up and down arrow keys, if you want to save the changes in memory, then press ENTER. On LED indication are displayed the new values of selected item.

5.4.4 CHANNEL STATUS screen

Position: Open from main screen by pressing twice the right arrow.

N	MODE	SP	TEMP	OUT
1	AUTO	280°	279	34
2	MAN	65%	nC	65
3	AUTO	280°	280	40

Access rights: **OPERATOR.**

Description:

On this screen can be changed mode and setpoint, and also monitor current value of temperature and output. Information on the screen is displayed in five columns: zone number, zone mode, setpoint, zone temperature and output percentage. Simultaneously are viewed parameters of three zones. Desired zone number is opened by up and down arrow keys.

In the mode column, there are the following possibilities: OFF - zone is switched off, AUTO - automatic mode, MAN- manual mode, SL- slave mode.

In the setpoint column is displayed a different value, depending on zone mode:

Mode	Parameter in column for setpoint	Value
OFF	Setting temperature in automatic mode.	0..999 [°C]
MAN	Setting output in manual mode. After the setpoint follows %.	0..100 [%]

AUTO	Setting the temperature in automatic mode.	0..999 [°C]
SL	Zone number, to which is slaved manually the current zone. After the number follows the letter z . If 0 – the zone is in off mode.	0,1..N N-number of zones

In “Temp” column is displayed the current zone temperature, and if sensor is faulty *nC* is displayed.

In the “Out” column is displayed the output value at the particular moment.

In order to change a parameter the following actions should be done:

1. Go to the desired zone number by up or down arrow key.
2. Press EDIT. Mode of upper screen zone begins to flash.
3. Go to the desired parameter by pressing right arrow.
4. If the parameter is a mode, set desired mode by up or down arrow. If parameter is a setpoint, enter the desired value through the numeric keypad.
5. Press ENTER.
6. If you want to change other parameters, repeat actions from item 3, 4 and 5.
7. Press EDIT to end edit mode.

5.4.5 TEMPERATURES IN THE CONTROLLER screen

Position: Open from main screen by pressing three times right arrow.

RAD1=45	RAD2=48
RAD3=60	
CPU=25	OT1=25.4
OT2=25.3	OT3=25.4

Access rights: **ADJUST**

Description:

Information on this screen indicates measured temperatures of different areas in the controller. RAD1, RAD2 and RAD3 are temperatures of power (output) modules. CPU is temperature of processor module. OT1, OT2 and OT3 are temperatures of sensors for compensation of thermocouple cold end. These temperatures are designed most of all for diagnostic.

5.4.6 ZONES SETTING screens

Position: Open from main screen by pressing down arrow.

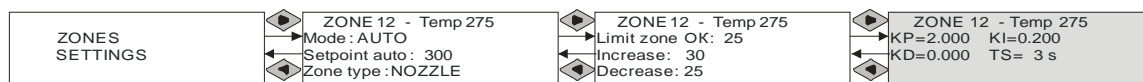

Necessary access rights: **OPERATOR / ADJUST**

Description:

In this menu are carried out monitoring and setting of all parameters separately for each zone. Parameters are arranged on 3 screens, shifting between them is done by right and left arrow. Select zone by up or down arrow. On the top most line is displayed the zone number and its current temperature (*nC* in case of problem with sensor). In the table below find description of zone parameters.

Parameter	Meaning	Value	Factory setting
-----------	---------	-------	-----------------

Parameter	Meaning	Value	Factory setting
Mode	Zone mode. Types of modes: switched off (OFF), manual (MAN), automatic (AUTO) and slave (SL).	OFF MAN AUTO SL	AUTO
Setpoint in auto*	Setpoint for zone temperature in automatic mode.	0..999 [°C]	30
Setpoint in manual*	Setpoint for zone output, when in manual mode.	0..100 [%]	0
SL to zone*	Parameter has two meaning, depending on zone mode: - In AUTO mode indicates to which zone automatically slave current zone in case of sensor failure, in order to continue operation in control mode. Value 0 induces passing into FAILURE mode in case of sensor failure. - In SL mode indicates zone, to which current zone is manually slaved. Value 0 is considered that zone is in OFF mode.	0, 1..N N-number of zones	0
Type of zone	Sets the type of zone - quick (NOZZLE) or slow (MAINFOLD). Specifying type of zone, assigns for parameters of PID controller factory defaults, which save user's trouble to specify and manually enter them. If parameters of PID controller change from these set for NOZZLE and MAINFOLD, the text OTHERS is displayed. Setpoint of OTHERS does not lead to change of parameter values of PID controller.	NOZZLE MAINFOLD OTHERS	NOZZLE
Limits zone OK	Temperature difference compared to setpoint in whose range zone is with operating temperature and failure is not caused. For example, if setpoint is 300°C and for "Limits zone OK" is set to 25, it follows that admissible operating temperature is from 276°C to 325°C.	0..99 [°C]	25
Boost	Value by which is increased setpoint in BOOST mode.	0..99 [°C]	25
Standby	Value by which is decreasing setpoint in STANDBY mode.	0..400 [°C]	30
KP**	Proportional gain of PID controller.	0.000..99.999	2.0
KI**	Integral gain of PID controller.	0.000..99.999	0.2

Parameter	Meaning	Value	Factory setting
KD**	Derivative gain of PID controller.	0.000..99.999	0.0
TS**	Output PWM period.	1..255 s	3 s

* These parameters are visualized in relation to selected mode of zone: at OFF or AUTO mode is visualized “Setpoint auto” parameter; at MAN mode - “Setpoint manual” parameter; at SL mode - “SI to zone” parameter.

** Screen for setting of PID controller parameters is accessible only at access level **ADJUST**. For more details about setting of PID controller parameters see item 6.9.

5.4.7 FAILURE SETTINGS screens

Position: Open by main screen by pressing down arrow twice

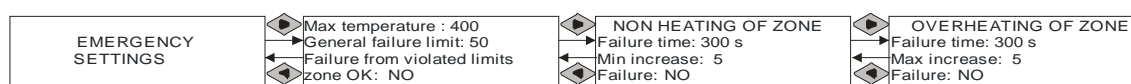

Access rights: **OPERATOR**

Description:

Parameters of FAILURE SETTINGS are arranged on 3 screens, shifting between them is done by left or right arrows. In the table below is given description of failure setting parameters.

Parameter	Meaning	Values	Factory setting
Max. temperature	Maximum admissible temperature, up to which can be heated any zone. When increasing this temperature HR goes into FAILURE mode.	0..500 [°C]	400
Common failure limit	Deviation from setpoints when there is no alarm if zone temperatures are within this deviation. E.g. if any zone has setpoint 300°C and for “Common failure limit” is set 50, there is no alarm signal if its temperature is between 251°C and 350°C.	0..999 [°C]	50
Failure violated limits zone OK	Parameter determines whether if temperatures are not within “Limits zone OK” of setpoints, to go into FAILURE mode (if YES) or continue operation (if NO).	YES NO	NO

Parameter	Meaning	Values	Factory setting
Failure time – zone non heating screen	If a given time (“Failure time”) output of some zone is switched on at 100%, and its temperature does not BOOSTwith given degrees (“Min. increase”), it is accepted that the zone is not heating. At zero in this parameter failure is not monitored. When setting time, take into consideration the slowest zones.	0..3000 [s]	100
Min. increase- non heating zone sreen	If for a given time ("Failure time") temperature of some zone has increased less than setpoint in this parameter (at output 100%), main screen displays message for non heating of zone and ALR LED of respective zone begins to flash. If alarm allowed (next parameter), HR goes into FAILURE mode.	0..999 [°C]	5
Failure- screen zone non heating	Parameter sets whether, if some zone is not heating, HR enters into FAILURE mode (if YES) or continues operation (if NO).	YES NO	NO
Failure time - zone overheating screen	If for a given time (“Failure time”) output of a zone has been set at 0%, while its temperature has increased with given degrees (“Max. increase”), it is accepted that the zone is overheating. If zero in this parameter failure is not monitored.	0..3000 [s]	100
Max. BOOST- zone overheating screen	If for a given time ("Failure time") temperature of a zone has increased more than setpoint in this parameter (at output 0%), the main screen displays message about overheating of zone and ALR LED of respective zone begins to flash. If alarm allowed (next parameter), HR goes into FAILURE mode.	0..999 [°C]	5
Failure - zone overheating screen	Parameter sets whether, if a zone is overheating, HR enters into FAILURE mode (if YES) or continues work (if NO).	YES NO	NO

5.4.8 MODE CHANGE screen

Position: Open from main screen by pressing down arrow three times left arrow once.

MODE CHANGE
 StartNOStopNO
 BoostNO :
 StandbyNO:

Access rights: OPERATOR.

Description:

Parameter	Values	Meaning
Start	No / YES	Parameter has constant value NO. Selection of YES and pressing of ENTER (value automatically returns to NO) starts regulation (if start conditions fulfilled).
Stop	NO / YES	Parameter has constant value NO. Selection of YES and pressing ENTER (value automatically returns to NO) stops regulation.
BOOST	NO / YES	Parameter value indicates current mode. When YES controller goes into BOOST mode, only if has been in CONTROL, STANDBY or WARM UP mode. If in BOOST mode, when NO controller goes in CONTROL mode.
STANDBY	NO / YES	Parameter value indicates current mode. When YES controller goes in STANDBY mode, only if has been in CONTROL, BOOST or WARM UP mode. If in STANDBY mode, when NO, controller goes into CONTROL mode.

All commands of MODE CHANGE menu are doubled by independent keys on the front panel.

5.4.9 GENERAL SETTINGS screens

Position: Open from main screen by pressing down arrow three times.

GENERAL SETTINGS	MODES Soft start: YES Warm up: YES MAX Increase 1000 s	ANALOGUE INPUTS Type: J Filter: 0	Digital input function I-START, 0-STOP Digital output function ALWAYS ON	COMMUNICATION Mode: 1 Master: YES Speed: 9600 Nr of modes: 3 Safe: NO	GLOBAL SETTINGS Language: BULGARIAN Factory settings: NO Rights: OPERATOR
------------------	---	---	---	--	--

General settings screens will be explained separately.

5.4.9.1 MODES screen

Position: Open from GENERAL SETTINGS screen by pressing right arrow once.

Access rights: OPERATOR.

Description:

Parameter	Meaning	Values	Factory setting
Soft start	This parameter determines whether when controller starts to enter into SOFT START mode (if YES) or to skip this mode (if NO). For more information about modes see item 4.1.	YES NO	YES

Parameter	Meaning	Values	Factory setting
Heating	This parameter determines whether when controller starts to pass through WARM UP mode (if YES) or to skip this mode (if NO). For more information about modes see item 4.1.	YES NO	NO
MAX. Increase	Maximum time which HR is in BOOSTmode. After this time is over, controller automatically goes into CONTROL mode.	0..3000 [s]	300

5.4.9.2 ANALOGUE INPUTS screen

Position: Open from GENERAL SETTINGS screen by pressing right arrow twice.

Access rights: **OPERATOR**.

Description:

Parameter	Meaning	Values	Factory setting
Type	Sets thermocouple type. This is a text parameter, so change is made by up or down arrows.	J K	J
Filter	Sets the coefficient of exponential filter to analogue inputs. The filtering is minimum at 1 and maximum at 999. No filter at 0.	0..999	0

5.4.9.3 DIGITAL INPUT AND DIGITAL OUTPUT screen

Position: Open from GENERAL SETTINGS screen by pressing right arrow three times.

Access rights: **OPERATOR**.

Description:

Parameter	Meaning	Values	Factory setting
-----------	---------	--------	-----------------

Parameter	Meaning	Values	Factory setting
Function of digital input	<p>Sets function of digital input (accessible from rear panel) of HR. Optional variants are:</p> <p>1-BOOST– raising front of digital input induces entering into BOOSTmode.</p> <p>1-STANDBY– falling front of digital input induces entering into STANDBYmode</p> <p>1-START, 0-STOP – connection of input brings controller into control mode, and its disconnection - into STOP.</p> <p>N/A – connection of input does not induce reaction of HR.</p>	<p>1-BOOST</p> <p>1-STANDBY</p> <p>1-START,0-STOP</p> <p>N/A</p>	N/A
Function of digital output	<p>Sets function at digital output (accessible from rear panel) of HR. Optional variants are:</p> <p>ON: FAILURE – output is on, when controller is in Failure mode.</p> <p>ON: TEMPERATURES OK – output is on, if zone temperatures are in "Limits zone OK".</p> <p>ALWAYS ON – digital output is on, if controller is not in STOP or FAILURE mode.</p> <p>ALWAYS OFF – digital output is constantly off.</p>	<p>ON: FAILURE</p> <p>ON:TEMPERATURES OK</p> <p>ALWAYS ON</p> <p>ALWAYS OFF</p>	<p>ALWAYS OFF</p>

For more information about digital inputs and outputs, see item 9.1.

5.4.9.4 COMMUNICATION screen

Position: Open from GENERAL SETTINGS screen by pressing right arrow four times.

Access rights: **OPERATOR.**

Description:

Parameter	Meaning	Values
Node	Number of controller in communication network	1..31
Master	Sets whether controller is master (if YES) or SLAVE (if NO).	YES NO
Speed	Speed of communication in bauds. Parameter is changed by up or down arrows.	9600 bauds 38400 bauds

Parameter	Meaning	Values
Number of nodes	Number of nodes, which master covers at every network scanning. Parameter is changed by up or down arrows.	3 31
Save	Saving of parameters. When selecting YES (by up arrow) communication parameters are saved. Otherwise changes made in other parameters are ignored.	YES NO

Communication parameters do not change from factory settings and settings reading. For more details about communication see item 9.3 and 9.4. For more details about protocol RI485 and its parameters, see document "Description of protocol RI485" of company 'Ring Injenering'.

5.4.9.5 GLOBAL SETTINGS screen

Position: Open from GENERAL SETTINGS screen by pressing right arrow five times.

Access rights: OPERATOR / ADJUST

Description:

Parameter	Meaning	Values	Factory setting
Language	Language of menus and messages.	Bulgarian English	Bulgarian
Factory setting	Saving YES in this parameter sets all other parameters in values, given in tables of this manual in factory setting columns. Attention! Saving YES will cause loss of all current settings, made by you about separate parameters. You can store current settings by menu SAVE/READ SETTINGS.	YES NO	NO
Rights	By this parameter access rights to menus are changed. Change is done by pressing up or down arrow, entering password and press again up down arrow.	OPERATOR ADJUST	OPERATOR

5.4.10 SAVE / READ SETTINGS screens

Position: Open from main screen by pressing down arrow four times.

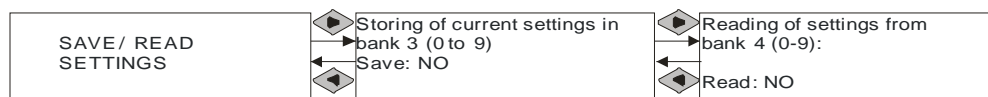

Access rights: OPERATOR

Description:

Menus SAVE / READ SETTINGS serve to save or read all parameters (including zone parameters) in a separate bank (from 0 to 9). This provides quick readjustment of parameters for operation with at least 10 various moulds.

Both screens contain parameters “bank” (number from 0 to 9) and command for “Read” or “Save”. **When reading settings, controller must be in STOP mode.** In addition “Read settings from bank” screen, gives information whether settings are exactly read. Possible messages are:

Text	Meaning
CONFIG NOT SAVED!	Configuration not saved in assigned bank. Parameters remain unchanged.
READING SUCCESSFUL!	Configuration successfully read and all parameters are with the values, saved in specified bank.
MODULE NOT IN STOP!	Controller not in STOP mode. Parameters remain unchanged.

You can find additional information about setting saving and reading in item 6.10.

5.4.11 CONFORMITY TEST screens

Position: Open from main screen by pressing down arrow five times.



Access rights: **OPERATOR**

Description:

By settings in these menus conformity test of wiring of heaters and thermocouples of each zone is carried out. Test is carried out only with zones, which are configured in automatic mode.

Test is carried out as follow:

- Start heating of zone 1 (if configured in auto mode) and then monitored whether the temperature of zone 1 will increase with no less that set in parameter “Min. increase”, for less time that set in parameter “Max. time increase”
- If zone temperature increases more than “Min. increase”, there is conformity between heater and temperature sensor and pass to test next zone.
- If after the time “Max time increase” zone temperature has not reached “Min increase”, then is read number of zone, which has maximum temperature increase. In test results of this zone is saved number of thermocouple, which has maximum increase. If this maximum increase is less than “Min. increase”, then after sensor number is put “?”.
- after test completion of zone, it is switched off and wait for time set in “Waiting between zones”, then pass to test of next zone.

In the table below is given description of conformity test parameters.

Parameter	Meaning	Values	Factory setting
-----------	---------	--------	-----------------

Parameter	Meaning	Values	Factory setting
Min increase	Set in degrees what is the temperature increase to accept that sensor is in conformity with heater	0..99 [°C]	20
Max. time incr.	Set time for which temperature of the slowest zone will increase to value, set in previous parameter.	0..9999 [s]	100
Waiting b/n zones	Set time of waiting between tests of two consequent zones. There is no waiting when setpoint is 0	0..999 [s]	0
TEST START	Setpoint YES in this parameter starts conformity test	YES NO	NO

After starting conformity test the controller automatically shows the main screen. It visualizes the number of currently tested zone (which heater is on), temperature increase of this zone and zone number with maximum increase, as well as remaining time until test end.

After test end, if all sensors correspond to heaters: "CONFORMITY TEST SUCCESSFUL" appears, and if there are shifted sensors and heaters - "CONFORMITY TEST UNSUCCESSFUL".

Conformity test can be interrupted at any time by holding down STOP key. After such interrupting on the screen appears "CONFORMITY TEST INTERRUPTED BY USER. Press ESC to continue".

5.4.12 Screen CLOCK.

Position: Open from main screen by pressing down arrow six times and consequent pressing of left arrow.

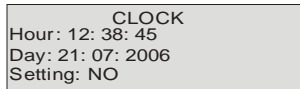

Access rights: **ADJUST.**

Description:

Screen is used for setting and monitoring of calendar clock, built-in in controller. Clock is mainly used by the events log function.

Clock setting is carried out as follows: press EDIT key, consecutively enter values of hour, minute, second, day, month and year, then select YES, to save entered values.

5.4.13 EVENTS screen

Position: Open main screen by pressing down arrow six times.

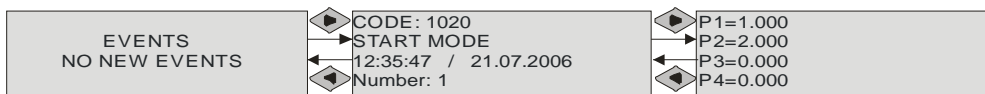

Access rights: **ADJUST.**

Description:

EVENT screens serve to display information about when, what situations and events are registered by controller (e.g. starting and stopping of device supply; entering into START, STOP mode; occurring of failure situations, etc.). Each event is recorded with date and hour and number of repetitions, showing consequent occurring of one and the same event. Apart from that, each event is accompanied with up to four parameters (represented by P1, P2, P3 and P4). In the example given on the figure, value of parameter P1=1 means that controller is started in SOFT START mode. Full description of optional events is given in application to this document.

5.4.14 OUPUT MODULES screens

Position: Open from main screen by pressing down arrow seven times.

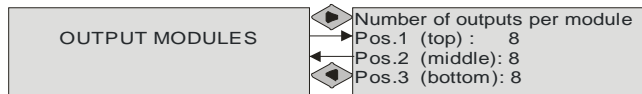

Access rights: **ADJUST**

Description:

Each HR controller has three positions for output (power) modules, accessible from the rear panel. From this menu you can see types of output modules, put on respective positions.

5.5 Description of messages on status screen.

Main screen of controller serves for appearance of different messages. In the following tables are described possible messages, grouped according to controller operating mode.

STOP mode

Screen	EXPLANATION
STOP MODE HOLD START key Zones in auto mode: 16 SL: 5 MAN: 3	Normal screen in STOP mode. Controller is in STOP mode, but is ready for START mode. Set number of zones, which will start in respective modes, by pressing and holding down START key.
STOP MODE Zones in auto mode without sensors: 01 11 13 15	There are zones, which are configured in automatic mode, but there is a problem with their sensors. Up to 4 numbers of zones without sensors are displayed. Controller can not be started in such situation.
STOP MODE ATTENTION! All zones are off!	All zones are in OFF mode. Controller can not be started in such situation.
STOP MODE Zones with temperatures exceeding maximum: 12	There are zones with temperatures above maximum. Up to 4 numbers of zones are displayed. Controller can not be started in such situation.

Screen	EXPLANATION
<div style="border: 1px solid black; padding: 5px; width: fit-content;"> STOP MODE Temperature of power module 2 above admissible! </div>	Radiator temperature of power module is above admissible. Controller could not be started in such situation.
<div style="border: 1px solid black; padding: 5px; width: fit-content;"> STOP MODE Temperature in controller above admissible! </div>	Controller temperature is above admissible. Controller can not be start in such situation.
<div style="border: 1px solid black; padding: 5px; width: fit-content;"> STOP MODE Wrong configuration Enter new parameters ENTER to continue </div>	Lost parameters. After connecting to the power source, controller reads parameters from a nonvolatile memory and checks them. In case of a problem, this message is displayed. It is necessary to check all parameters and enter the lost ones.
<div style="border: 1px solid black; padding: 5px; width: fit-content;"> STOP MODE CONFORMITY TEST SUCCESSFUL Press ESC to continue </div>	<p>On this screen is displayed conformity test result. On the second line message may be:</p> <ul style="list-style-type: none"> - 'COMPLETED SUCCESSFULLY' – in case of conformity of all heaters and sensors - 'COMPLETED UNSUCCESSFULLY' – in case of non conformity even of one heater or sensor - 'ABORTED BY USER' – if user has aborted the test before completing. <p>Close this screen by pressing ENTER or ESC.</p>

SOFT START mode

Screen	Explanation
<div style="border: 1px solid black; padding: 5px; width: fit-content;"> SOFT START Stage: 1 Output percentage: 1 End in 20 sec. </div>	Gives information about soft start stage, output percentage of all started zones, as well as remaining time till the end of the stage.

WARM UP mode

Screen	Explanation
<div style="border: 1px solid black; padding: 5px; width: fit-content;"> HEATING STAGE Coldest zone: 12 temperature 103 elapsed time 340 s </div>	Gives information for leading (most cold) zone, its temperature and elapsed time from beginning of WARM UP mode.

CONTROL mode

Screen	Explanation
<div style="border: 1px solid black; padding: 5px; width: fit-content;"> CONTROL Press and hold up STOP key to STOP </div>	<p>Normal screen in CONTROL mode.</p> <p>Pressing and holding down of STOP key brings controller in STOP mode.</p>

Screen	Explanation
<p>CONTROL Possible burnt heater of zone: 01 03</p>	<p>There is zone or zones which do not heat. Numbers of up to 4 zones are displayed. The text appears for 5 seconds, then again appears the normal text for CONTROL mode. At such event controller remains in CONTROL mode, only if zone non heating alarm is disabled.</p>
<p>CONTROL Possible short circuited triac of zones: 01 03</p>	<p>There are zone outputs, which could not be controlled. Numbers of up to 4 zones are displayed. The text appears for 5 seconds, and then appears the normal text for CONTROL mode. At such event, controller remains in CONTROL mode, only if zone overheating alarm is disabled.</p>
<p>CONTROL Zone 12 automatically slaved to zone 01</p>	<p>A zone is automatically slaved to another zone. Text appears for 5 seconds, and then appears normal text for CONTROL mode.</p>

BOOST mode

Screen	Explanation
<p>BOOST Remaining time: 312 s Press and hold up STOP key to STOP</p>	<p>Normal screen in BOOST mode. Indicates remaining time until automatic entering into CONTROL mode. Pressing and holding down of STOP key brings controller in STOP mode.</p>

STANDBY mode

Screen	Explanation
<p>STANDBY Press and hold up STOP key to STOP</p>	<p>Normal screen in STANDBY mode. Pressing and holding down of STOP key brings controller in STOP mode.</p>

FAILURE mode

Screen	Explanation
<p>FAILURE No sensor for the following zones: 01 03 13</p>	<p>Numbers of up to 4 zones failed sensors are displayed, and on LED indication glow ALR LEDs of all zones with such failure.</p>
<p>FAILURE Zone with temperature above maximum: 01 03 13</p>	<p>Numbers of up to 4 zones are displayed with temperatures above maximum, and on LED indication glow ALR LEDs of all zones with such failure.</p>
<p>FAILURE Power module temperature exceeds the limit!</p>	<p>Exceeded admissible temperature of power module.</p>

Screen	Explanation
<p>FAILURE Temperature in controller exceeds limits!</p>	Exceeded admissible temperature in controller.
<p>FAILURE Possible burnt heater of zones: 12 13</p>	Numbers of up to 4 zones are displayed, which have problem with heating, and on LED indication glow ALR LEDs of all zones with such failure.
<p>FAILURE Out of limits OK zones: 13</p>	Numbers of up to 4 zones are recorded, whose temperature is out of 'Limits zone OK', and on LED indication glow ALR LEDs of all zones with such failure.
<p>FAILURE Out of failure limits zones: 13</p>	Numbers of up to 4 zones are recorded, whose temperature is out of failure limits, and on LED indication glow ALR LEDs of all zones with such failure.
<p>FAILURE Possible uncontrollable heater of zones: 13 15</p>	Numbers of up to 4 zones are displayed, whose temperature increases, although heating is stopped, and on LED indication glow ALR LEDs of all zones with such failure.

By pressing ESC or ENTER failure is reset - ERROR LED fades. On main screen appears some of STOP mode screens.

During conformity test

Screen	Explanation
<p>CONFORMITY TEST Test zone: 12 dT:7° Max. zone: 13 dT14° Remaining: 0:5:52</p>	Number of tested zone is displayed, increasing (dT) of this zone temperature, number of zone with maximum increase and its increase, as well as maximum remaining time until the end of the test.

6 MAIN OPERATIONS WITH HR

The aim of this item is to give in a brief main and most frequent operations on setting and control of HR device.

6.1 Setpoint change of one zone

In order to change the setpoint of one zone, the following actions have to be carried out:

1. Hold up MENU key, to go to the main screen.
2. Press left arrow once, to enter screen CHANGE OF SETPOINT.
3. Press up or down arrow until on the screen appears zone number, whose setpoint should change.
4. Press EDIT key, to enter into EDIT mode.
5. By the right or left arrow go to the respective setpoint.
6. From numeric keypad select a new setpoint and press ENTER.
7. Press EDIT key to end edit mode.

6.2 Change mode of one zone

To change mode of one zone, the following actions have to be carried out:

1. Hold up MENU key, to go to the main screen.
2. Press right arrow twice, to go to CHANNEL STATUS screen.
3. Press keys up or down arrow until on screen appears zone number, whose mode should be change.
4. Press EDIT key, to enter into edit mode.
5. Using right or left arrow go to the respective mode.
6. Using up or down arrow select desired mode and press ENTER key.
7. Press EDIT key for end of edit mode.

6.3 Setpoint change of several consequent zones

In order to change setpoint of several consequent zones, the following actions are carried out:

1. Hold up MENU key, to go to main screen.
2. Press right arrow to go to PARAMETERS CHANGE screen (the same result can be reached only with arrows, without going through item 1).
3. Press EDIT and on the LCD begins to flash area of parameters for change, and on LED indicators – values of currently displayed parameter.
4. By down arrow (or up arrow, depending on current parameter) select SETPOINT parameter and press ENTER.
5. Assign from numeric keypad first channel, for which is valid change of setpoint and press ENTER.
6. Set from numeric keypad lat channel, for which is valid change of setpoint and press ENTER.
7. Set new value of setpoint (e.g. 280) and press ENTER.
8. Press up arrow to enter YES in Change parameter.
9. Press ENTER.

In this way can be simultaneously changed values of all types of channel parameters. For more details see item 5.4.3.

6.4 Start

To start controller it is enough to press and hold down START key from any menu. However to start controller should be fulfilled START conditions. A sign that controller is ready to start is that on the main screen is displayed normal status screen of START mode.

Starting can be done by MODE CHANGE menu, by setting YES in START parameter (see item 5.4.1).

STOP MODE HOLD START key Auto mode zones : 16 SL: 5 MAN: 3
--

6.5 Stop

To stop controller is enough to press and hold down STOP key. The key directly brings controller in STOP.

Controller can be also stopped from MODE CHANGE menu, by setting YES in STOP parameter (see item 5.4.1).

6.6 BOOST

To enter into BOOST mode, it is necessary to press and hold down BOOST key, located on the front panel near LED indication (see item 5.1)

BOOST mode can also be started from MODE CHANGE menu, by setting YES in the BOOST parameter (see item 5.4.1).

Controller **does not enter** into BOOST mode, if current mode is STOP, FAILURE or SOFT START.

6.7 STANDBY.

To enter into STANDBY mode, it is necessary to press and hold down STAND BY key, located on the front panel near LED indication (see item 5.1.)

STANDBY mode can be started also from CHANGE MODE menu, by setting YES in STANDBY parameter (see item 5.4.1).

Controller does not enter into STANDBY mode, if current mode is STOP, FAILURE or SOFT START.

6.8 Monitoring of parameters on the LED indication

On glowing LED indication can be monitored some parameters of separate channels. For monitoring of:

- Current temperatures - press PV key
- Setpoint of temperature - press SP key
- Percentage at output - press OUT key
- Difference between setpoint and current temperature – press DIFF key.

You can understand which parameter is visualized on indication at the moment from the LED next to the respective key.

By menu PARAMETERS CHANGE you can monitor the remaining zone parameters. Press EDIT key in menu and through up or down arrow select desired parameter. In this case (at visualization of a parameter, which is not from the above four parameters) none of LEDs is lit on keys PV, SP, OUT and DIFF.

If when monitoring current temperatures you press and hold down PV key, on LED indication only remain zone values, which are in automatic mode, these which

temperature is out of 'Limits temperature OK', are flashing. In this way you can quickly receive information about which zones have sensors and which zones have reached operating temperature. Returning into initial mode of temperatures display is done by pressing and holding down of PV key.

For more details, see item 5.1.

6.9 Setting of PID parameters

In most cases to have good operation of controller is enough to set type of zone – nozzle or manifold. Selection of one of these two types sets PID parameters in following values:

Parameter	Nozzle	Mainfold
TS – Scanning time, sec.	3	20
KP – Proportional gain	2	2
KI – Integral gain	0.2	0.2
KD – Derivative gain	0	0

If these settings do not ensure the correct and stable maintaining of set temperatures, it is necessary to manually change PID controller parameters.

PID controller parameters can be changed only through ADJUST access rights.

6.10 Storing and reading of all settings.

For storing of all parameters in a given bank, the following actions should be completed:

1. Go to SAVE / READ SETTINGS screen (by pressing down arrow four times from main screen).
2. Press once right arrow.
3. Press EDIT key.
4. From numeric keypad enter bank number, where to store the parameters. Acceptable bank numbers are from 0 to 9.
5. Press ENTER.
6. Press up arrow for selection of YES in 'Save' parameter, then press ENTER. By this configuration is stored in indicated bank.

To display parameters from bank (**controller should be in STOP mode**), from SAVE / READ SETTINGS menu, are carried out following actions:

1. Press right arrow twice, to go to the menu for reading configuration.
2. Press EDIT.
3. Enter from numeric keypad bank number (from 0 to 9), from which should be read configuration and press ENTER.
4. In 'Read' parameter, pressing up arrow to record YES, then press ENTER.

If the parameters have been read successfully, on the third line displays 'READ SUCCESSFUL!'.

For more details when reading or saving settings see item 5.4.10.

6.11 Setting of failure parameters

Below is given diagram with model of setting the values of various failure parameters, related to temperature of one zone.

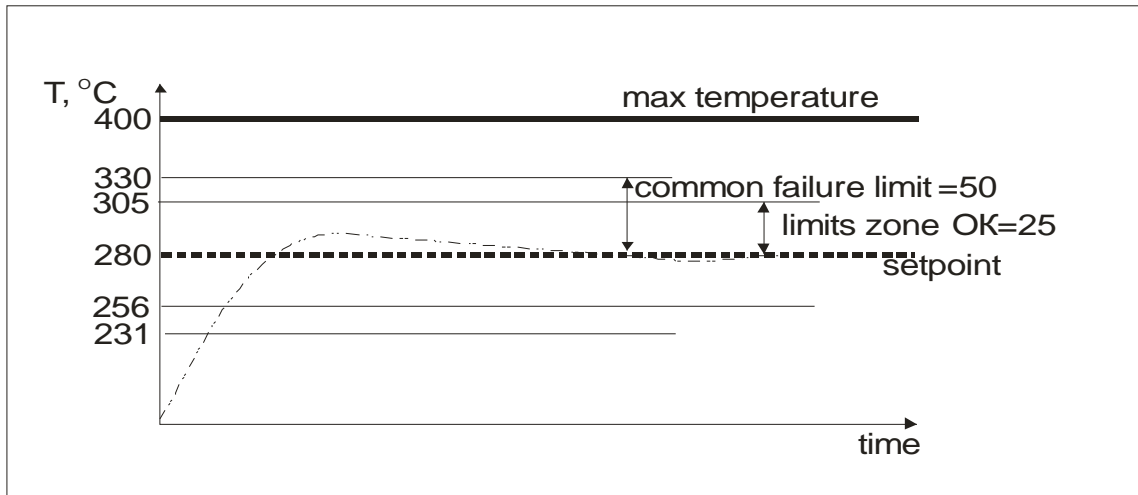

On the given figure zone and failure parameters settings are as follows:

Zone setting - 280°C.

Limits zone OK - 25. This means that zone temperature is OK if in the range from 256 to 305 degrees.

Common failure limit - 50. It means that the zone will induce failure from violated failure limits if goes out of the 231 - 330 degrees range.

Maximum temperature - 400°C. The zone will induce failure from exceeded maximum temperature, if its temperature exceeds 400°C.

7 STARTING OF THE CONTROLLER FOR THE FIRST TIME

7.1 Installation.

HR controller is put on a level and stable surface, without vibrations, away from heating sources, dust and static electricity (operating conditions are described in technical data), with provided free space for air circulation around radiators on rear panel.

7.2 Connection of cables and switching on power supply.

Before switching on power supply, it is necessary to connect cables to temperature sensors, heaters and supply source.

Connecting of cables to the matrix is carried out by power connectors (HD). For signals to temperature sensors are used male connectors on the HR side, while to the heaters, female connectors. Layout of signals on these connectors is given in application. Check if outputs match these of the matrix before coupling connectors one to another.

Controller is powered through 5-wire system - 3x230VAC, zero and earthing. Check the compliance of supply voltage, before coupling supply cables. Order of phases is not important.

Switching on of controller power supply is done from the switch on rear panel. After powering up of HR controller, all segments of LED indication start glowing, and on LCD displays 'START DIAGNOSTIC HRxx / RING INJENERING / VERNON xx DATExx" for about 3 seconds. During this time operation of all LED segments can be checked. Controller is set by default in STOP mode after powering up, in order to avoid heating before setting by user.

7.3 Initial setting of zones

Go through factory settings of parameters in respective tables. Check controller signalization for missing of temperature sensors by pressing PV key of LED indicators measured temperature is displayed or nC if a sensor is missing. For initial start of heating (when available temperature sensors), normally it is enough to adjust zone type, operating mode and their temperature setpoint.

7.4 Setting of main parameters

Factory parameters of HR controller are such that they ensure operation in high percent of cases. However, before the first start the user should adjust at least the following parameters:

- *Type of input sensors.* Controller supports J and K type thermocouples. By default is selected J type. If your thermocouples are K type, you should set in ANALOGUE INPUTS menu K in the 'Type' parameter (see 5.4.9.2)

- *Zone mode.* By default all zones are in AUTO mode. It is necessary to set mode of zones, which will not operate in automatic mode. The easiest way is from CHANNEL STATUS menu (see item 5.4.4).

- *Setpoint of zones.* By default all setpoints are at 30°C. Zone setpoints are changed in the same way as in previous item.

- *Zone type.* By default all zones are set as nozzles. For better control, it is necessary zones from 'mainfold' type to be preconfigured. This is done from

PARAMETERS CHANGE menu or ZONE SETTINGS menu (see parts 5.4.3 and 5.4.6).

These are minimum parameters, which user should set. Moreover it is better to check and set following parameters:

- *Maximum temperature*. This is a parameter from FAILURE SETTINGS menu. By default its value is 400°C. If you work with higher temperature values, you should increase this parameter.

- *Limits zone OK*. This is a parameter, individual for each zone and indicates its temperature operating limits. If all zones are within these limits, LED t^ook is lit. Factory default of this parameter is 25°C.

- *BOOST and STANDBY*. These parameters indicate how much to increase (or decrease) temperatures of each zone in BOOST (STANDBY) mode. Factory settings are 25°C for BOOST and 30°C for STANDBY.

7.5 Start and stop of heating.

To start heating, press and hold down for about 1 sec. the START key. If there is no failure, on the front panel will glow green RUN LED and will hear clicking of internal contactor, which powers up all zones. Controller will enter into selected mode of heating, displayed on LCD main screen. On zones with setpoint higher than the measured temperature OUT LEDs will begin to glow.

To stop heating of all zones, press and hold down STOP key for about 1 sec. On the front panel will fade green RUN LED and hear clicking of internal contactor, which switches off power to zones. At the same time stops glowing of OUT diodes near LED indicators.

8 FAILURES

In this part will be studied possible causes, leading to controller malfunction. That includes occurrence of failure situations (failed sensor, overheated zone, etc.), as well as failure of controller due to defects and troubles.

8.1 Failure events and causes

Failure	Possible causes	Ways of elimination
Wrong configuration	Controller has wrongly read configuration from FLASH memory, when powering up. Possible cause powering down during saving in this memory.	Check all parameters and adjust these with incorrect values. If you have saved parameters as recipe (through SAVE/READ SETTINGS menu), first try to read them from there.
Missing zone sensor	<ol style="list-style-type: none"> 1. Faulty sensor. 2. Damaged analogue input. 3. Bad connections or wire breakage. 4. Wrongly connected sensor. 	<ol style="list-style-type: none"> 1. Measure and possibly change sensor. 2. Check analogue input. Call service if damaged. 3. Tighten terminals or replace wires. 4. Reconnect wires, coming from sensor.
Zone temperature exceeding maximum temperature	<ol style="list-style-type: none"> 1. Uncontrollable heater (output has short circuited and heats up constantly). 2. Parameter entered for maximum temperature - with low value or too high zone set value. 3. PID parameters are improperly selected and there is high overshoot. 4. Failure in temperature sensor or HR analogue input. 5. Discrepancy of wiring between sensor and heater. 	<ol style="list-style-type: none"> 1. Check in OFF mode of respective zone whether its temperature increases (in HR CONTROL mode). Replace burnt output element. 2. Increase parameter for maximum temperature or decrease set value for respective zone. 3. Check configuration for zone type (whether it is nozzle or manifold). Adjust PID parameters. 4. See 'Zone sensor missing'. 5. Check and correct discrepancy between sensor and heater.

Failure	Possible causes	Ways of elimination
Temperature of output module above admissible maximum (100°C)	<ol style="list-style-type: none"> 1. Poor cooling of controller. 2. Operating temperature above admissible. 3. Damaged fan of power modules. 4. Damaged power supply of fans. 5. Damaged temperature sensor of module. 	<ol style="list-style-type: none"> 1. Ensure at least 20 cm free space behind controller. 2. Ensure admissible operating conditions. 3. Change fan. 4. Contact service for repair of power supply. 5. From GLOBAL SETTINGS menu, change ADJUST access level. On CONTROLLER TEMPERATURE screen, see radiator temperatures, more precisely the readings of RADx, where x is module number. If temperature visibly differs from radiator real temperature, change respective sensor.
Temperature in controller above admissible (70°C)	<ol style="list-style-type: none"> 1. Poor cooling of controller. 2. Operating temperature is above admissible. 2. Failed internal fan. 3. Failed power supply of fans. 4. Failed CPU temperature sensor. 	See above row.
Non heating of zone	<ol style="list-style-type: none"> 1. Burnt fuse. 2. Burnt heater. 3. Burnt output. 4. Broken connections. 5. Incorrect parameters in ZONE HEATING menu. 6. Short circuit sensor. 	<ol style="list-style-type: none"> 1. Measure and change fuse, if burnt. 2. Measure and change heater, if burnt. 3. Start the zone in manual mode and setpoint 100%, and see whether there is voltage at output connector for respective zone. If missing, replace output element. 4. Check terminals and power wires. 5. Check and correct parameters in ZONE NON HEATING menu. 6. Measure and change sensor of respective zone.
There is no zone in mode, different from OFF	<ol style="list-style-type: none"> 1. Go to factory settings. 2. Reading of wrong configuration of parameters, when powering up. 	<ol style="list-style-type: none"> 1. Reconfigure modes to start controller. 2. See failure 'Wrong configuration'.
Zone temperature out of limits OK	See failure 'Zone temperature above maximum'.	See failure 'Zone temperature above maximum'.

Failure	Possible causes	Ways of elimination
Zone temperature out of failure limits	See failure 'Zone temperature above maximum'.	See failure 'Zone temperature above maximum'.
Overheated zone	<ol style="list-style-type: none"> 1. Uncontrollable heater (output short circuit and constantly heats up). 2. Damaged temperature sensor. 3. Discrepancy in wiring between sensor and heater. 	<ol style="list-style-type: none"> 1. Check in OFF mode of respective zone whether its temperature increases (in HR CONTROL mode). Replace burnt output element. 2. Measure zone sensor. Change if damaged. 3. Correct wiring of sensors and heaters.

8.2 Possible faults and their elimination

In case of failure of HR controller, contact service for repair. User can manage by themselves with cases of burnt fuse only.

8.2.1 Burnt zone fuse

Causes of zone fuse burning could be: short circuit of heater, condensed fluid on heater, short circuit of connector wires. Before replacing the fuse, check if there is short circuit.

To change zone fuse, following actions should be carried out:

1. Disconnect controller power supply from supply cable or at least bring the controller into STOP mode.
2. Unwind fuse of burnt zone.
3. Replace the fuse with a new one. **ATTENTION! Replace fuses only with such of the same type and the same value!**

For protection of output device, use fast fuses (type FF). Their replacement with another type can induce controller failure.

4. Carefully wind fuse cap and start the device.

8.2.2 Burnt fuse of controller.

If when powering on nothing starts to glow on front panel, most probably, either there is no supply or controller fuse has burnt (F25 - located on rear panel). If there is no power, LED of rear panel switch does not glow (when switch is on). If LED glows, most probably controller fuse, which is immediately to the power switch, has burnt. Causes for controller fuse burning could be power surge or failure in controller.

For changing controller fuse, carry out following actions:

1. Switch off controller supply cable.
2. Unwind fuse cap.
3. Replace fuse by a new one of the same type and the same value.
4. Wind the cap, connect controller supply cable and power on.

If after change, fuse burns again, contact the service for repair.

If controller fuse is normal and has voltage, and on front panel does not glow any indication, the problem is internal and you should contact a service for repair.

9 ADDITIONAL CAPABILITIES OF HR.

Apart from main function, related to individual temperature control, controller has additional capabilities, allowing its connection to pressure gun control, as well as joint operation of several HR controllers. These functions are implemented by digital inputs and outputs or through communication.

9.1 Digital inputs and outputs with general purpose.

HR has 1 digital output and 1 digital input, whose functions are set from controllers keyboard. (see item 5.4.9.3). Connector with terminals of digital input and output is located on rear panel (see applications).

For digital input control it is necessary to connect dry contact to its terminals. Example of a connection diagram is given in item 3.8. Events, which digital input could induce, are configured by keyboard and are described in the following table:

Function	Meaning
N/A	Supply to input does not induce reaction by HR.
1-START, 0-STOP	Rising of digital input (transition 0->1) will induce controller start, and falling front – STOP.
1-STANDBY	Rising of digital input induces runing to STANDBY mode. Falling front switches off STANDBY.
1-BOOST	Rising of digital input induces runing BOOST mode. Rear front switches off BOOST.

Input action results from its status change (and not from its status). Consequently remains the option to change mode from keyboard.

Digital output is a relay with normally open contact. Example of connection diagram is given in item 3.9.

Digital output could inform for particular states of HR. Possible functions of output are set by keyboard and are described in the following table.

Function	Meaning
ALWAYS OFF	Digital output is always off.
ALWAYS ON	Digital output is on, if controller is not in STOP or FAILURE mode.
ON:TEMPERATURES OK	Output is on, if temperatures of all zones are in 'Limits zone OK'.
ON: FAILURE	Output is on, when controller is in FAILURE mode.

9.2 Connecting in joint control with pressure gun

Digital output and input of HR allow its connection to joint control with pressure gun. Below is given an example diagram.

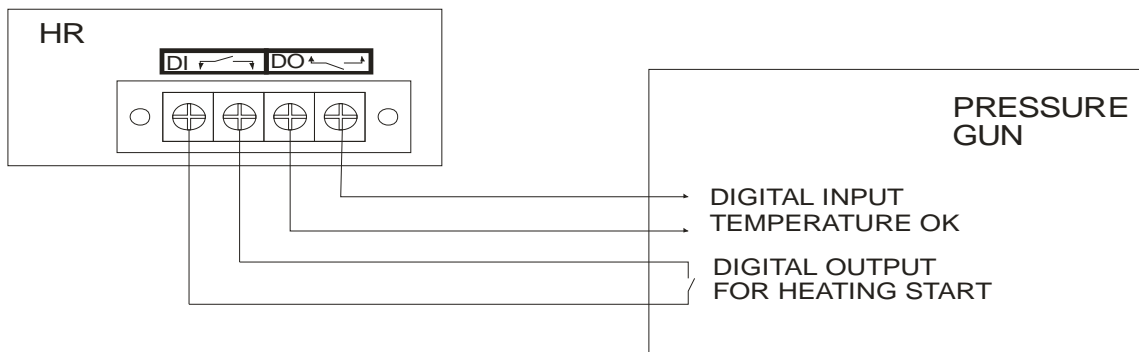

In indicated connection, digital input is configured as '1-START, 0-STOP', while digital output - as 'ON: TEMPERATURES OK'. In this way pressure gun can control start and stop of heating and receive feedback whether zone temperatures are in admissible limits.

9.3 Communication

HR controller supports communication protocols, allowing connection of several HR controllers. In this software version is supported only RI485 protocol.

On rear panel is installed a connector type Canon-9 (see part 3.10). Connection of several controllers in network is mainly done by this connector.

RI485 communication allows connecting to computer for monitoring and storing of temperatures, reading of events, etc.

9.4 Parallel operation of several HR controllers.

It is possible to simultaneously switch START and STOP modes, as well as LED indications of several controllers, by pressing respective keys of any controller. For this purpose is necessary their connection by RI485 communication and to carry out following setting in COMMUNICATION menu:

Node – Each controller should have unique value, beginning with number 1.

Master – Only one controller should be with YES in this parameter. We recommend you to make master controller number 1.

Speed – Speed should be the same for all controllers (9600 or 38400).

Number of nodes – this parameter is important only for Master node. Parameter has two possible values 3 and 31. If controllers are 2 or 3, select 3, if more – select 31.

To save settings in COMMUNICATION menu, you should assign YES in 'Save' parameter.

To establish connection between controllers, it is necessary to short circuit signals A and B of communication connector. (see part 3.10)

APPLICATION 1. Description of events

Below are described the user's events, saved by HR during operation in EVENTS menu.

Code	Meaning
1020	Control started. In P1 is saved mode of starting of controller. Meaning of values: P1=1- mode SOFT START P1=2- mode WARM UP P1=3- mode CONTROL
1021	Control stopped. In P1 is saved the controller mode before the STOP mode: P1=1- mode SOFT START P1=2- mode WARM UP P1=3- mode CONTROL P1=4- mode BOOST P1=5- mode STANDBY
2000	Wrong CRC of parameters configuration
2001	Failed thermocouple of zone in automatic mode. In parameters P1..P4 are saved up to 4 zones (their numbers are from 1..N, where N is the total number of zones).
2002	Zone temperature above maximum. In parameters P1..P4 are saved up to 4 zones (their numbers are from 1..N, where N is the total number of zones).
2003	Power module temperature above permissible. Parameter P1- module number: 1- upper, 2- middle, 3- lower. Parameter P2- lag time (in seconds) from radiator overheating until recording of this event.
2004	Temperature in controller above admissible.
2005	Non heating of zone. In parameters P1..P4 are saved up to 4 zones (their numbers are from 1..N, where N is the total number of zones).
2006	Zone temperature out of 'Limits zone OK'. In parameters P1..P4 are saved up to 4 zones (their numbers are from 1..N, where N is the total number of zones).
2007	Zone temperature out of 'Common failure limits'. In parameters P1..P4 are saved up to 4 zones (their numbers are from 1..N, where N is the total number of zones).
2008	Automatically slaved zone. In parameter P1 is saved its number, and in P2 – to which zone it is slaved.
2009	Error when reading configuration of output modules. In P1 is saved: P1=1-wrong CRC of parameters. P1=2- wrong value of output numbers.
2010	Overheated zone. In parameters P1..P4 are saved up to 4 zones (their numbers are from 1..N, where N is the total number of zones).

APPLICATION 2. Signal layout of external connectors

1ST MODIFICATION – CONNECTORS HD16 AND HD32 OF REAR PANEL

On the diagram below is given view of HR24 rear panel.

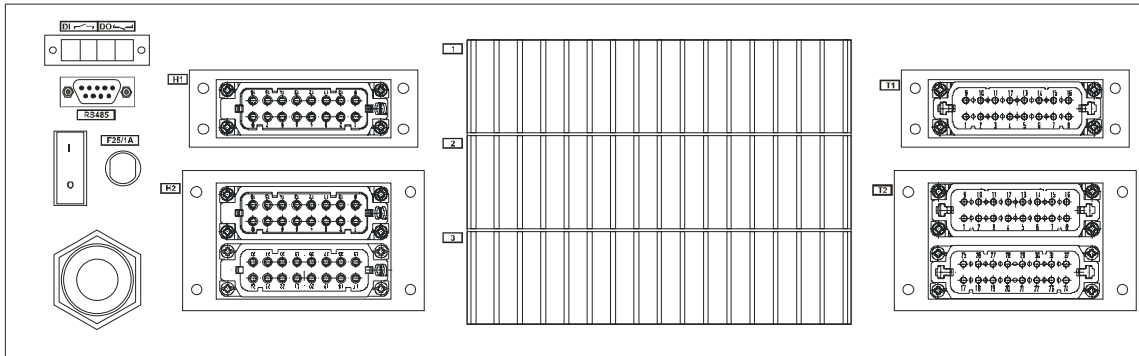

Connector outputs are designed for:

Connector H1 (HD16 female connector) – heaters of zones 1-8

№	Purpose	№	Purpose
1	heater zone 1	9	heater zone 1 (zero)
2	heater zone 2	10	heater zone 2 (zero)
3	heater zone 3	11	heater zone 3 (zero)
4	heater zone 4	12	heater zone 4 (zero)
5	heater zone 5	13	heater zone 5 (zero)
6	heater zone 6	14	heater zone 6 (zero)
7	heater zone 7	15	heater zone 7 (zero)
8	heater zone 8	16	heater zone 8 (zero)

Connector H2 (HD32 female connector) – heaters of zones 9-24.

№	Purpose	№	Purpose
1	heater zone 9	9	heater zone 9 (zero)
2	heater zone 10	10	heater zone 10 (zero)
3	heater zone 11	11	heater zone 11 (zero)
4	heater zone 12	12	heater zone 12 (zero)
5	heater zone 13	13	heater zone 13 (zero)
6	heater zone 14	14	heater zone 14 (zero)
7	heater zone 15	15	heater zone 15 (zero)
8	heater zone 16	16	heater zone 16 (zero)
17	heater zone 17	25	heater zone 17 (zero)
18	heater zone 18	26	heater zone 18 (zero)
19	heater zone 19	27	heater zone 19 (zero)
20	heater zone 20	28	heater zone 20 (zero)
21	heater zone 21	29	heater zone 21 (zero)
22	heater zone 22	30	heater zone 22 (zero)
23	heater zone 23	31	heater zone 23 (zero)
24	heater zone 24	32	heater zone 24 (zero)

Connector T1 (HD16 male connector) – **thermocouples of zones 1-8.**

№	Purpose	№	Purpose
1	thermocouple zone 1 (+)	9	thermocouple zone 1 (-)
2	thermocouple zone 2 (+)	10	thermocouple zone 2 (-)
3	thermocouple zone 3 (+)	11	thermocouple zone 3 (-)
4	thermocouple zone 4 (+)	12	thermocouple zone 4 (-)
5	thermocouple zone 5 (+)	13	thermocouple zone 5 (-)
6	thermocouple zone 6 (+)	14	thermocouple zone 6 (-)
7	thermocouple zone 7 (+)	15	thermocouple zone 7 (-)
8	thermocouple zone 8 (+)	16	thermocouple zone 8 (-)

Connector T2 (HD32 male connector) – **thermocouples of zones 9-24.**

№	Purpose	№	Purpose
1	thermocouple zone 9 (+)	9	thermocouple zone 9 (-)
2	thermocouple zone 10 (+)	10	thermocouple zone 10 (-)
3	thermocouple zone 11 (+)	11	thermocouple zone 11 (-)
4	thermocouple zone 12 (+)	12	thermocouple zone 12 (-)
5	thermocouple zone 13 (+)	13	thermocouple zone 13 (-)
6	thermocouple zone 14 (+)	14	thermocouple zone 14 (-)
7	thermocouple zone 15 (+)	15	thermocouple zone 15 (-)
8	thermocouple zone 16 (+)	16	thermocouple zone 16 (-)
17	thermocouple zone 17 (+)	25	thermocouple zone 17 (-)
18	thermocouple zone 18 (+)	26	thermocouple zone 18 (-)
19	thermocouple zone 19 (+)	27	thermocouple zone 19 (-)
20	thermocouple zone 20 (+)	28	thermocouple zone 20 (-)
21	thermocouple zone 21 (+)	29	thermocouple zone 21 (-)
22	thermocouple zone 22 (+)	30	thermocouple zone 22 (-)
23	thermocouple zone 23 (+)	31	thermocouple zone 23 (-)
24	thermocouple zone 24 (+)	32	thermocouple zone 24 (-)

FOR HR8 AND HR16 LAYOUT IS AS HR24, BUT THERE ARE NO SIGNALS AND RELEVANT CONNECTORS OVER THEIR NUMBER OF ZONES.

2ND MODIFICATION – DIRECT CABLES TO MATRIX WITH HD24

On this diagram is given HR24 rear panel view.

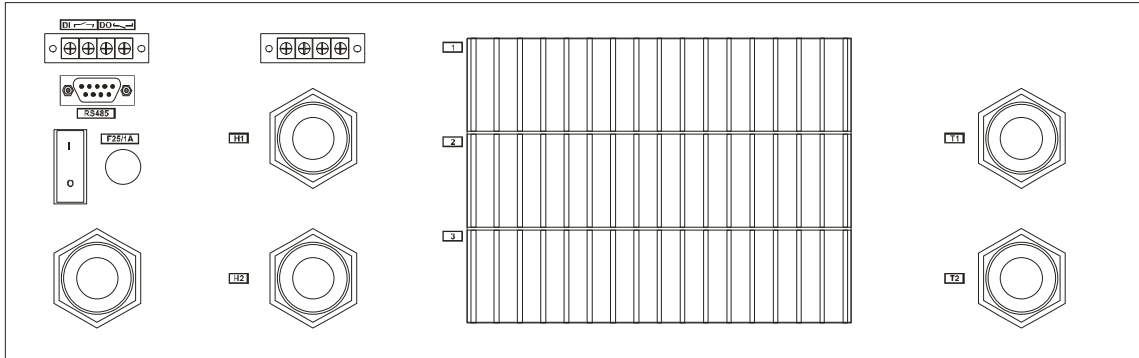

Connector outputs are designed for:

Connector H1 (HD24 female connector) – **heaters of zones 1-12.**

№	Purpose	№	Purpose
1	heater zone 1	13	heater zone 1 (zero)
2	heater zone 2	14	heater zone 2 (zero)
3	heater zone 3	15	heater zone 3 (zero)
4	heater zone 4	16	heater zone 4 (zero)
5	heater zone 5	17	heater zone 5 (zero)
6	heater zone 6	18	heater zone 6 (zero)
7	heater zone 7	19	heater zone 7 (zero)
8	heater zone 8	20	heater zone 8 (zero)
9	heater zone 9	21	heater zone 9 (zero)
10	heater zone 10	22	heater zone 10 (zero)
11	heater zone 11	23	heater zone 11 (zero)
12	heater zone 12	24	heater zone 12 (zero)

Connector H2 (HD24 female) - **heaters of zones 13-24.**

№	Purpose	№	Purpose
1	heater zone 13	13	heater zone 13 (zero)
2	heater zone 14	14	heater zone 14 (zero)
3	heater zone 15	15	heater zone 15 (zero)
4	heater zone 16	16	heater zone 16 (zero)
5	heater zone 17	17	heater zone 17 (zero)
6	heater zone 18	18	heater zone 18 (zero)
7	heater zone 19	19	heater zone 19 (zero)
8	heater zone 20	20	heater zone 20 (zero)
9	heater zone 21	21	heater zone 21 (zero)
10	heater zone 22	22	heater zone 22 (zero)
11	heater zone 23	23	heater zone 23 (zero)
12	heater zone 24	24	heater zone 24 (zero)

Connector T1 (HD24 male connector) - **thermocouples of zones 1-12**

№	Purpose	№	Purpose
1	thermocouple zone 1 (+)	13	thermocouple zone 1 (-)
2	thermocouple zone 2 (+)	14	thermocouple zone 2 (-)
3	thermocouple zone 3 (+)	15	thermocouple zone 3 (-)
4	thermocouple zone 4 (+)	16	thermocouple zone 4 (-)
5	thermocouple zone 5 (+)	17	thermocouple zone 5 (-)
6	thermocouple zone 6 (+)	18	thermocouple zone 6 (-)
7	thermocouple zone 7 (+)	19	thermocouple zone 7 (-)
8	thermocouple zone 8 (+)	20	thermocouple zone 8 (-)
9	thermocouple zone 9 (+)	21	thermocouple zone 9 (-)
10	thermocouple zone 10 (+)	22	thermocouple zone 10 (-)
11	thermocouple zone 11 (+)	23	thermocouple zone 11 (-)
12	thermocouple zone 12 (+)	24	thermocouple zone 12 (-)

Connector T2 (HD24 male connector) – **thermocouples of zones 13-24**

№	Purpose	№	Purpose
1	thermocouple zone 13 (+)	13	thermocouple zone 13 (-)
2	thermocouple zone 14 (+)	14	thermocouple zone 14 (-)
3	thermocouple zone 15 (+)	15	thermocouple zone 15 (-)
4	thermocouple zone 16 (+)	16	thermocouple zone 16 (-)
5	thermocouple zone 17 (+)	17	thermocouple zone 17 (-)
6	thermocouple zone 18 (+)	18	thermocouple zone 18 (-)
7	thermocouple zone 19 (+)	19	thermocouple zone 19 (-)
8	thermocouple zone 20 (+)	20	thermocouple zone 20 (-)
9	thermocouple zone 21 (+)	21	thermocouple zone 21 (-)
10	thermocouple zone 22 (+)	22	thermocouple zone 22 (-)
11	thermocouple zone 23 (+)	23	thermocouple zone 23 (-)
12	thermocouple zone 24 (+)	24	thermocouple zone 24 (-)

FOR HR8 AND HR16 THE LAYOUT IS AS OF HR24, BUT THERE ARE NO SIGNALS AND RELEVANT CONNECTORS ABOVE THEIR NUMBER OF ZONES.